

HVAC|R



QUALITY TOOLS FOR CLIMATE CONTROL



Klein Tools supports VOTECH schools with the following programs:

VOTECH Student Discount

All VOTECH orders through distributors will receive discounts.

Tool Donation Program

Upon review and approval Klein Tools will provide product donations for qualifying programs where Klein Tools are being used in the training labs.



Top Student Award Program

Reward the top-performing student in each graduating class.



Custom Tool Kits developed through collaboration with local instructors are available upon request.

Klein Tools Educational Mission

Foster a Healthy North American Economy & HVAC Industry

- Invest in the training & education of tomorrow's workforce
- Grow U.S. manufacturing
- Facilitate hands-on student experiences with our products

For more information, contact your Klein Tools representative or our HVAC team at HVAC@kleintools.com



www.kleintools.com

TABLE OF CONTENTS

Pliers	2-3
Pump Pliers	4
Wire Strippers/Cutters/Crimpers	5
Multi-Purpose Tools	6
Sheet Metal Tools	7
HVAC Tools	8-9
Cutting Tools	10-11
Knives	12-13
Screwdrivers	14
Multi-Bit Drivers	15-16
Precision Drivers	17
Nut Drivers	18
Wrenches	19-20
Hex Keys	21
Hammers	22
Levels & Measuring	23-24
Wire Pulling	25
PPE - Hard Hats, Gear, Workwear	26-33
Illumination	34
Power	35
Jobsite Accessories	36-37
Test & Measurement.....	38-45
Tool Storage.....	46-49
Tool Kits.....	50-51

These days, it can be hard to find companies that make products you can count on.

But that's exactly what you'll get from Klein Tools. We don't just make great products, we make great products that stand up to the demands of the professionals who use them every day. Because our standards are as high as yours, we demand that every product we offer delivers all the performance, durability and precision that you need to get the job done right.

And by using only the highest quality materials, superior workmanship, and keeping our manufacturing as close to home as we can, we're able to uphold those rigorous standards.

So buy a Klein tool and you'll know what all the professionals know... when you pick up a Klein, it'll never let you down.

That's why we're the choice of professionals in the USA

See www.kleintools.com/warranty for more information.

⚠ WARNINGS/CAUTIONS:
For all products, see www.kleintools.com

Warranty Returns

All warranty returns must include a Warranty Return Authorization (WRA) number. The WRA for the U.S. can be obtained by calling Customer Service at 1-800-553-4676. (International call 1-847-821-5500) or email serviceonline@kleintools.com.

Specifications of all products in this catalog are subject to change without notice.

Dimensions shown for all forged products in this catalog are as precisely accurate as possible, but subject to very slight variations that are unavoidable in forging and grinding operations. Dimensions of Klein forged tools and all other tools and equipment are always within commercial tolerances recognized for such products.

Warning Symbols

	Warning Symbol		Strong Magnetic Field		Do Not Push Or Hammer
	Wear Eye Protection		Laser Warning		Do Not Strike Hammer Faces Together
	Do Not Use On Or Near Live Electrical Circuits		Use Safe Work Position		Do Not Extend Handle Length
	Read Instructions Before Use		Pinch Point Hazard		Do Not Sit
	Risk Of Shock		Do Not Use To Chisel		Do Not Step or Stand
	For Use on Bare Live Conductor (Clamp Meter)		Do Not Use To Pry		Not For Fall Arrest
	Double Insulated		Not Personal Protective Equipment		Risk of Drowning

PLIERS

Core Plier Features

- Forged Steel from Klein's US made, proprietary blend
- Induction hardened cutting knives for long life
- Hot-riveted joint ensures smooth action and no handle wobble



High-Leverage Lineman's Pliers

Includes core High-Leverage Side-Cutting features plus:

- High-leverage design. 46% greater cutting and gripping power than other plier designs
- Precision-hardened plier head for on the job toughness
- Sure-gripping cross-hatched knurled jaws.
- Unique handle tempering helps absorb the "snap" when cutting wire

HANDLE FINISH



Plastic-Dipped



JOURNEYMAN™
Dual-Material



D213-9NE

Cat. No.	UPC# 0-92644+	Handle Color	Handle Finish	Overall Length
D213-8NE	70032-3	Dark Blue	Plastic-Dipped	8.59" (21.82 cm)
D213-9NE	70042-2	Dark Blue	Plastic-Dipped	9.33" (23.70 cm)
D2000-9NE	70082-8	Light Blue	Plastic-Dipped	9.33" (23.70 cm)
J213-9NE	72101-4	Dark Blue/Black	Journeyman™ Dual-Material	9.55" (24.26 cm)
D213-9NE-CR	70046-0	Yellow	Plastic-Dipped	9.33" (23.70 cm)

Hybrid Pliers with Crimper

- Strips 10-14 AWG solid and 12-16 AWG stranded wire with 6-32 and 8-32 bolt shearing
- High-leverage design for more cutting power
- Wide knurled head easily grabs and twists wires
- Dual-Material Journeyman™ grips are more comfortable and last longer than other handles
- Crimps non-insulated connectors, lugs and terminals
- Cat. No. J215-9CRTP quickly and easily pulls 1/8" or 1/4" (3 or 6 mm) flat steel fish tape without damaging the tape



J215-9CRTP

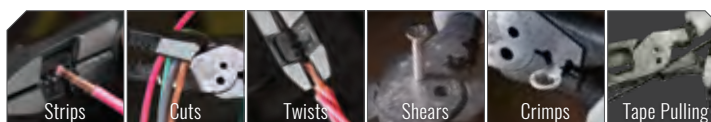

Cat. No.	UPC# 0-92644+	Strips and Cuts (AWG)		Screw Shearing	Handle Color	Handle Finish	Overall Length
		Solid	Stranded				
J215-8CR	70258-7	10-14	12-16	6-32, 8-32	Gray/Black	Journeyman™ Dual-Material	8.232" (20.92 cm)
J215-9CRTP	70151-1	10-14	12-16	6-32, 8-32	Gray/Black	Journeyman™ Dual-Material	8.981" (22.81 cm)

High-Leverage Diagonal-Cutting Pliers

Includes core High-Leverage Diagonal-Cutting features plus:

- High-leverage design; 36% greater cutting power than other plier designs
- Angled head design for easy work in confined spaces (Cat. Nos. D248-8, J248-8)



D2000-28

Cat. No.	UPC# 0-92644+	Cutting Knives	Handle Color	Handle Finish	Overall Length
D228-7	72038-3	Standard	Red	Plastic-Dipped	7" (17.78 cm)
D228-8	72040-6	Standard	Red	Plastic-Dipped	7.98" (20.27 cm)
With heavy-duty cutting knives designed to cut ACSR, screws, nails and most hardened wire					
D2000-28	72092-5	Standard	Light Blue	Plastic-Dipped	7.98" (20.27 cm)
Angled Head					
D248-8	72070-3	Standard	Red	Plastic-Dipped	8.05" (20.45 cm)
J248-8	72109-0	Standard	Red/Black	Journeyman™ Dual-Material	8.16" (20.73 cm)



All-Purpose Pliers

Includes core Pliers features plus:

- Strips 10-18 AWG solid and 12-20 AWG stranded wire and crimps non-insulated connectors, lugs and terminals
- Knurled jaw for grabbing and looping wire
- 6-32 and 8-32 screw shearing



CRIMPING FEATURE
J207-8CR



J207-8CR

Cat. No.	UPC# 0-92644+	Point Diameter	Knife Length	Handle Color	Handle Finish	Overall Length
J207-8CR	38405-9	0.15" (0.38 cm)	0.5" (1.27 cm)	Yellow/Black	Journeyman™ Dual-Material	8.48" (21.54 cm)

Side-Cutting Long-Nose Pliers

Includes core Pliers features plus:

- Heavier design for greater cutting power
- Knurled jaws for grabbing and looping wire
- Induction-hardened cutting knives for long life
- Extended handles provide added reach and greater leverage
- Curved handles provide greater tool control



12 AWG WIRE STRIPPING
AND CRIMPING
D203-8NCR

HANDLE FINISH



Plastic-Dipped



JOURNEYMAN™
Dual-Material



D203-6

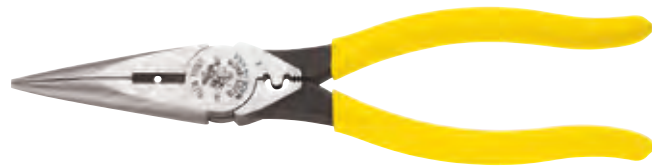

D203-8NCR

Cat. No.	UPC# 0-92644+	Point Diameter	Knife Length	Handle Color	Handle Finish	Overall Length
Heavy-Duty Design With Extended Handles						
D203-8	71028-5	0.125" (0.32 cm)	0.693" (1.8 cm)	Yellow	Plastic-Dipped	8.41" (21.36 cm)
D203-8NCR	71034-6	0.125" (0.32 cm)	0.693" (1.8 cm)	Yellow	Plastic-Dipped	8.42" (21.39 cm)
J203-8	72111-3	0.125" (0.32 cm)	0.693" (1.8 cm)	Yellow/Black	Journeyman™ Dual-Material	8.42" (21.39 cm)
Standard Design With Curved Handles						
D203-6	71016-2	.094" (0.24 cm)	0.572" (1.45 cm)	Yellow	Plastic-Dipped	6.67" (16.94 cm)
J203-6	71013-1	.094" (0.24 cm)	0.572" (1.45 cm)	Yellow/Black	Journeyman™ Dual-Material	6.75" (17.15 cm)

Precision Flush Cutter

- Shears wire up to 16 AWG producing a flat, flush cut
- Shear cutting greatly reduces cutting effort and minimizes fly-off
- Molded flared grips for greater tool control
- Steel return spring for increased comfort during repetitive cutting
- Ultra slim profile increases access in confined areas
- Heat treated for increased durability



D275-5

Cat. No.	UPC# 0-92644+	Cutting Knives	Handle Color	Handle Finish	Overall Length
D275-5	72080-2	Flush	Red	Textured	5.05" (12.83 cm)



PUMP PLIERS



Klaw™ Pump Pliers

- Compact, narrow design for easy work in small or hard to reach spaces
- Gripping surfaces with specially hardened teeth for reduced wear and positive gripping
- Extended grips for added comfort
- **Quick-Adjust Pump Pliers:** Push button and quick ratchet feature allows for fast and easy adjustment to any position. (Cat. Nos. D504-10B and D504-12B)



D504-7



D504-10B

Cat. No.	UPC# 0-92644+	Jaw Capacity	Handle Color	Handle Finish	Overall Length
Quick-Adjust Klaw™ Pump Pliers					
D504-10B	73047-4	2.125" (5.4 cm)	Yellow	Plastic-Dipped	10.24" (26.01 cm)
D504-12B	73049-8	2.75" (7 cm)	Yellow	Plastic-Dipped	12.6" (32.00 cm)
Classic Klaw™ Pump Pliers					
D504-7	73045-0	1.375" (3.5 cm)	Yellow	Plastic-Dipped	7.13" (18.11 cm)
D504-12	73048-1	2.75" (7 cm)	Yellow	Plastic-Dipped	11.81" (30.00 cm)

Pump Pliers

- Secure tongue and groove design for non-slip grip - even with heavy pressure
- Wide range of versatile jaw positions
- Quick adjust rivet allows one handed, fast and easy adjustment of plier jaws
- TT pliers feature split tether ring for securing tool when working at height



D502-6

HANDLE FINISH



Plastic-Dipped



JOURNEYMAN™
Dual-Material

Cat. No.	UPC# 0-92644+	Jaw Capacity	Handle Color	Handle Finish	Overall Length
D502-6	73002-3	0.875" (2.2 cm)	Yellow	Plastic-Dipped	6.53" (16.59 cm)
D502-10	73010-8	1.75" (4.5 cm)	Yellow	Plastic-Dipped	10.02" (25.45 cm)
D502-12	73018-4	2.375" (6 cm)	Yellow	Plastic-Dipped	12.19" (30.96 cm)
J502-10	73015-3	1.75" (4.5 cm)	Yellow/Black	Journeyman™ Dual-Material	10.25" (26.04 cm)



WIRE STRIPPERS/CUTTERS/CRIMPERS



Heavy-Duty Wire Strippers **KLEIN-KURVE®**

- The durability of a plier with the sharpness and precision of a wire stripper
- Twists up to three wires at a time
- Forged steel from Klein's US propriety blend
- Crimps non-insulated connectors, lugs and terminals for 10-20 AWG stranded wire



K12065CR

Cat. No.	UPC# 0-92644+	Strips and Cuts		Crimps	Screw Shearing	Handle Color	Overall Length
		Solid AWG	Stranded AWG	Stranded AWG			
K12065CR	34027-7	8-18	10-20	10-20	6-32, 8-32	Blue/White	8" (20.3 cm)

Wire Strippers/Cutters/Crimpers **KLEIN-KURVE®**

- Cuts and strips solid and stranded wire
- Crimps insulated and non-insulated connectors
- Tip designed to grab, pull and bend the smallest of wires
- Reinforced head reduces flex
- Optimized for ideal leverage when stripping and crimping
- Precision shear-type cutting blades for easier cutting
- Double dipped Klein Kurve™ comfort grips
- Do not use for cutting steel wire or bolts
- Patent US D827,403



Insulated Connectors



Non-Insulated Connectors

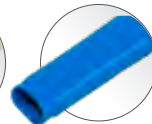

B-Connectors

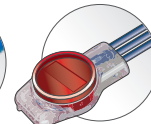

UR IDC
VDV826-605

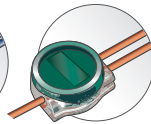

UG IDC

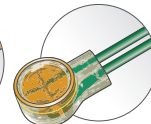

UY IDC
VDV826-604



1009

Cat. No.	UPC# 0-92644+	Strips and Cuts		Screw Shearing	Crimping Capacity	Handle Color	Handle Finish	Overall Length
		Solid AWG	Stranded AWG					
1009	74509-6	10-20	12-22	6-32, 8-32	10-22 AWG Insulated and Non-insulated Terminals	Gray/Yellow	Double-Dipped	7.75" (19.7 cm)

Wire Strippers/Cutters **KLEIN-KURVE®**

- Easy-to-read markings
- Precision shear-type cutting blades for easier cutting
- Narrow nose fits into tight places
- Double dipped Klein Kurve™ comfort grips



11055

Cat. No.	UPC# 0-92644+	Strips and Cuts			Screw Shearing	Handle Color	Handle Finish	Overall Length
		Solid AWG	Stranded AWG	NM-B Cable				
11055	74057-2	10-18	12-20	—	6-32, 8-32	Blue/Yellow	Double-Dipped	7.4" (18.8 cm)

⚠ WARNING: Do NOT use for cutting steel wire or bolts

Standard Wire Strippers/Cutters

- Cuts, strips, loops solid and stranded wire
- Easy-to-read wire gauge markings on both sides for stripping in either direction
- Hardened steel with precision ground stripping holes
- Shear-type cutting blades for clean cuts
- Do not use for cutting steel wire or screws



11045

Cat. No.	UPC# 0-92644+	Strips and Cuts		Handle Color	Handle Finish	Overall Length
		Solid AWG	Stranded AWG			
11045	74045-9	10-18	—	Yellow	Textured	6.25" (15.9 cm)



MULTI-PURPOSE TOOLS



Multi-Purpose Long-Nose Tool

- Easily cuts and strips 10-20 AWG Solid and 12-22 Stranded wire
- Crimps 10-22 AWG insulated and non-insulated terminals and 7-8 mm ignition terminals
- Cleanly shears bolts
- Cutters and strippers are in front of the pivot for maximum ease-of-use in reaching into tight places
- Narrow, serrated pliers nose to pull, loop, and bend wire



1010

Cat. No.	UPC# 0-92644+	Strips and Cuts		Screw Shearing	Crimping Capacity	Handle Color	Overall Length
		Solid AWG	Stranded AWG				
1010	74404-4	10-20	12-22	4-40, 5-40, 6-32, 8-32, 10-32, 10-24	10-22 AWG Insulated, Non-Insulated Terminals, 7-8 mm Ignition Terminals	Blue	8.25" (20.96 cm)

Crimper/Stripper/Cutter

- Includes a dedicated crimper with a wire stripper and two cutters
- Specially hardened wire cutter in the nose
- Shear cutter below the rivet cuts copper wire
- Forged steel for added durability
- Textured grips for enhanced dexterity and integrated hang holes



2005N

Cat. No.	UPC# 0-92644+	Strips and Cuts	Crimps	Handle Color	Overall Length
		Stranded AWG	Capacity		
2005N	34033-8	10-18	10-22 AWG Insulated and Non-Insulated Terminals	Red	9" (23 cm)

Crimpers/Cutters

- Cut and crimp 10-22 AWG wire
- Tapered nose design for working in confined areas
- Crimping dies marked for insulated and non-insulated solderless terminals and connectors
- Specially hardened wire cutter in nose
- Hot-riveted joint for smooth action and no handle wobble



1005

Cat. No.	UPC# 0-92644+	Cuts and Crimps	Handle Color	Handle Finish	Overall Length
1005	74204-0	10-22 AWG Insulated and Non-Insulated Terminals	Red	Plastic-Dipped	9.6" (24.4 cm)



SHEET METAL TOOLS



Aviation Snips with Wire Cutter

- Serrated blades of forged steel for superior strength and durability
- Unique integrated wire cutter on outside of blade for duct and ceiling suspension wire
- Cuts 18 gauge steel and 22 gauge stainless steel
- Spring-action lock allows opening of tool with one handed operation
- Features color-coded comfortable contoured grips
- Convenient hang-hole for easy storage
- Conforms to ASME B107.16M performance standard



Cat. No.	UPC# 0-92644+	Type	Cutting Pattern	Color Code	Cutting Capacity	Cutting Length	Overall Length
1200L	76152-2	Aviation with Wire Cutter	Left/Straight	Red	18 Gauge Steel, 22 Gauge Stainless Steel	1.5" (3.8 cm)	10.063" (25.6 cm)
1201R	76153-9	Aviation with Wire Cutter	Right/Straight	Green	18 Gauge Steel, 22 Gauge Stainless Steel	1.5" (3.8 cm)	10.063" (25.6 cm)
1202S	76154-6	Aviation with Wire Cutter	Straight/Wide Curves	Yellow	18 Gauge Steel, 22 Gauge Stainless Steel	1.5" (3.8 cm)	10.063" (25.6 cm)

Tin Snips

- 12" (30.5 cm) long tool with high-carbon cutting blades
- Full 3.5" (8.9 cm) blades cut straight and wide curves
- Excellent for 24 gauge steel and 28 gauge stainless steel
- Easily cuts tin, copper, aluminum, soft metals and vinyl
- All steel construction for long life and durability
- Easily replaceable cutting blades (Cat. No. 89555)
- Large handles to accommodate gloves



Cat. No.	UPC# 0-92644+	Cutting Capacity	Cutting Length	Overall Length
89556	69081-5	24 Gauge Steel, 28 Gauge Stainless Steel	3.5" (8.9 cm)	12" (30.5 cm)

Snap Lock Punch

- Steel jaw easily punches 3/8" (1 cm) wide impressions on metal edges to easily join pieces of sheet metal, duct, or siding
- Compound-leverage mechanism for greater control and easy operation
- All-steel construction and nickel-chrome plated hardware provide long life and durability
- Convenient self-opening latch for one handed operation



Cat. No.	UPC# 0-92644+	Handle Color	Overall Length
86528	69089-1	Blue/Gray	8.4" (21.3 cm)

Hand Notcher

- Cuts 30° V shapes in sheet metal quickly and easily to make corners
- High-impact steel jaw with 13/16" (2.1 cm) maximum throat depth
- All steel construction with nickel-plate and black-oxide finish provides long life and durability
- Comfortable, contoured grips cover hardened steel handles
- For up to 24 gauge steel and 28 gauge stainless steel
- Convenient self-opening latch for one handed operation



Cat. No.	UPC# 0-92644+	Handle Color	Overall Length
86526	69088-4	Blue/Gray	9" (23.2 cm)



HVAC TOOLS

5-Blade Crimper

- Produces factory-precision indentations in stove pipe and round duct with just a squeeze
- Compound-leverage mechanism makes precise indentations
- Comfortable, contoured grips cover hardened steel handles
- All steel construction and nickel-plating provide long life and durability
- Convenient self-opening latch for one handed operation
- Crimps 24 gauge steel and 28 gauge stainless steel
- Convenient self-opening latch for one handed operation



86520

Cat. No.	UPC# 0-92644+	Jaw Size	Handle Color	Overall Length
86520	69071-6	1.75" (4.5 cm)	Blue/Gray	10.2" (26 cm)

Seamers – Straight and Offset

- 3" jaw folds 22 gauge steel and 24 gauge stainless steel
- Jaw marked in 1/4" increments for precise bending measurements
- Compound-leverage mechanism easily and accurately bends, seams, and flattens sheet metal
- All-steel construction and nickel-chrome plated hardware for long life and durability
- Convenient self-opening latch for one handed operation
- Comfortable, contoured grips cover hardened steel handles



86522



86524

Cat. No.	UPC# 0-92644+	Type	Jaw Size	Handle Color	Overall Length
86522	69086-0	Straight	3" (7.6 cm)	Blue/Gray	8.6" (21.9 cm)
86524	69087-7	Offset	3" (7.6 cm)	Blue/Gray	5.4" (13.7 cm)

Duct Cutter with Wire Cutter

- All-steel double edge blade easily cuts fiber board, fiberglass lined, and flexible ducts
- Built-in wire cutter for convenience
- Compound leverage mechanism for easy wire cutting
- Comfortable, contoured grips cover hardened steel handles
- All-steel construction and nickel-chrome plated hardware provides long life and durability
- Convenient self-opening latch for one handed operation



89554

Cat. No.	UPC# 0-92644+	Overall Length
89554	69080-8	12.5" (31.9 cm)

Serrated Duct Knife

- Cuts duct board and flexible duct
- Double-edged knife: fine edge and serrated
- Cushion-grip handle for comfort
- Includes puncture resistant nylon sheath with belt loop



DK06

Cat. No.	UPC# 0-92644+	Blade Length	Blade Material	Overall Length
DK06	76101-0	5.5" (14 cm)	Stainless Steel	10.781" (27.4 cm)

⚠WARNING: Blades are intended for cutting only, and should be handled and disposed of with care. Bending the blade can cause it to break, possibly resulting in bodily injury. Check local laws on legality of selling or possessing these knives.

Adjustable Hole Cutter

- Cuts 2" to 12" (5.1 to 30.5 cm) holes in sheet metal
- For up to 24 gauge steel and 26 gauge stainless steel
- Inch and centimeter measurement scales are molded into the body
- Quality bearings assure a long cutting life
- Installs into standard electric drill chucks
- Includes replacement bit and L-Style Hex-Key to tighten the bit
- Features an adjustable Pivot Point for accurate hole size



REPLACEMENT
DRILL BIT
89551



89552

Cat. No.	UPC# 0-92644+	Hole Diameter	Overall Length
89552	69079-2	2" to 12" (5.1 to 30.5 cm)	7.2" (18.3 cm)



Folding Tools

- Two folding depths: 3/8" (1 cm) and 1" (2.5 cm)
- Handy sight gauges for accurate depth alignment
- Made of heavy-duty 16 gauge steel for strength



86532

Cat. No.	UPC# 0-92644+	Folds	Overall Length
86530	69163-8	24 Gauge Steel, 28 Gauge Stainless Steel	12" (30.5 cm)
86532	69164-5	24 Gauge Steel, 28 Gauge Stainless Steel	18" (45.7 cm)
86534	69165-2	24 Gauge Steel, 28 Gauge Stainless Steel	24" (61 cm)

PVC Tube Cutter

- Handle latch keeps tool closed
- Rubberized grip with anti-impact design



88912

Cat. No.	UPC# 0-92644+	Cutting Capacity	Overall Length
88912	69078-5	1" (2.5 cm) O.D. Multilayer Plastic Tubing and Up To 3/4" (1.9 cm) Schedule 40 PVC	7.344" (18.7 cm)

Nylon Tie Tensioning Tools

- Designed for work with ties rated at 120 - 250 lb (54 - 113 kg)
- Tensions up to 65 lb of force (30 kg)
- Maximum tie width of 15/32" (1.2 cm)
- Handle grips for comfort



86570

Cat. No.	UPC# 0-92644+	Description	Overall Length
86570	86570-1	Nylon Tie Tensioning Tool	7.8" (19.2 cm)

Professional Tube Cutter

- Accurate 4 roller tracking system — no spiraling
- Professional reaming tool for stainless steel tubing
- Extra cutting wheel included in handle



88904

Cat. No.	UPC# 0-92644+	Cutting Capacity	Overall Length
88904	88904-2	1/8" to 1-3/8" (0.3 to 3.5 cm) Steel and Copper Tubing	6.031" (15.3 cm)

Professional Mini Tube Cutter

- Requires only 1-3/8" (3.5 cm) swing radius
- Perfect for tight space cutting
- Small convenient size; strong and durable tool
- Not designed for cutting stainless steel or hard tempered tubing



88910

Cat. No.	UPC# 0-92644+	Cutting Capacity	Overall Length
88910	69077-8	1/8" to 5/8" (0.3 to 1.6 cm)	1.469" (3.7 cm)

Ratcheting PVC Cutters

- Provide straight cuts 1/2"-2" I.D. (1.3 cm-5.1 cm) O.D. 5/8" - 2-1/2" (1.6 cm-6.4 cm) of white and gray schedule 40 and 80 PVC
- Quick, one-handed blade release
- Ratchet action allows easy, one-hand cutting
- No tools required for instant blade change
- Replacement blade and pin available



REPLACEMENT BLADE FOR 50034
50035



REPLACEMENT BLADE FOR 50031
50032



REPLACEMENT RETAINING PIN
50033



50031

Cat. No.	UPC# 0-92644+	PVC Cutting Capacity	Overall Length
50031	50031-2	O.D. 5/8" to 1-5/8" (1.6 to 4.1 cm); I.D. 1/2" to 1-1/4" (1.3 to 3.2 cm)	9" (22.9 cm)
50034	50034-3	O.D. 5/8" to 2-1/2" (1.6 to 6.4 cm); I.D. 1/2" to 2" (1.3 to 5.1 cm)	11" (27.9 cm)

⚠ WARNING: Do NOT cut cold PVC.

⚠ WARNING: Do NOT use to cut metallic pipes, cable or wire.



CUTTING TOOLS



Bi-Metal Hole Saws and Arbors

Bi-Metal Hole Saws

- Optimized for cutting steel including stainless steel
- Cuts precise holes in stainless steel and mild steel, drywall, ceiling tile, laminates, wood and plastic
- Multiple slots provide different leverage points to easily remove material
- Heavy-duty steel construction includes 5 mil back plate to withstand abuse
- The smallest hole saws feature hex-shaped base for easy removal from arbor

Arbors

- For use with electric drill sizes 1/2" (1.3 cm) and larger
- Fast and easy to engage and disengage hole saws
- Steel construction for long life
- 118° split point pilot bits
- Cat. No. 31905 includes arbor adapter for use with hole saws 1-3/8" (3.5 cm) and larger
- Hardened mandrels for long thread life



Cat. No.	UPC# 0-92644+	Hole Diameter	Pipe Tap Size*	Pipe Entrance Size**	For Use With
31914	31914-3	7/8" (2.2 cm)	3/4" (1.9 cm)	1/2" (1.3 cm)	31905
31918	31918-1	1-1/8" (2.9 cm)	1" (2.5 cm)	3/4" (1.9 cm)	31905
31922	31922-8	1-3/8" (3.5 cm)	—	1" (2.5 cm)	31905 or 31906
31928	31928-0	1-3/4" (4.5 cm)	1-1/2" (3.8 cm)	1-1/4" (3.2 cm)	31906
31932	31932-7	2" (5.1 cm)	—	1-1/2" (3.8 cm)	31906
31940	31940-2	2-1/2" (6.4 cm)	—	2" (5.1 cm)	31906

Hole-Saw Arbor Bits

Cat. No.	UPC# 0-92644+	Thread Length	Shank Diameter	Pins	For Use With
31905		1/2"-20	3/8"	N	All Klein Hole Saws
31906		5/8"-18	7/16"	Y	Klein Hole Saws 1-3/8" to 6-6/8" (2.6 to 17.1 cm)

Replacement Part

Cat. No.	Description
31907	Replacement Pilot Bit, 1/4" x 3-1/2"

* Pipe Tap Size - The sizes listed provide the necessary information whenever a pipe is to be threaded into tanks, boilers, etc. To secure the best results, the hole should be reamed before tapping with a reamer having a taper of 3/4" per foot. **Pipe Entrance Size - The sizes listed provide the necessary information for any given pipe size to have sufficient clearance to pass through beams, walls, bulkheads, etc.

Electrician's Hole Saw Kit

31902 8-Pc
UPC# 0-92644+ 31902-0
•
•
•
•
•
•
•
•
•
•

Sets includes rust-proof molded case

VACO® Step Drill Bits

- Step Drill Bit has 2 spiral flutes to remove chips and help pull the bit through material for faster cutting
- Titanium nitride coating dissipates heat for longer bit life
- 1/4-Inch hex shank for firm, positive grip in impact driver and standard drill
- Split point tip quickly starts hole cuts and prevents drifting when pressure is added
- Laser-etched hole size markings for quick size identification
- For use on steel (up to 16 gauge), wood, plastic, and aluminum

Cat. No.	UPC# 0-92644+	Description	Holes	Increment	Hole Size Ranges
25960	25960-9	VACO Step Drill Bit	3	-	7/8" to 1-3/8" (22.2 to 34.9 mm)
25961	25961-6	VACO Step Drill Bit	2	-	7/8" to 1-1/8" (22.2 to 28.6 mm)
25962	25962-3	VACO Step Drill Bit	12	1/16" (1.6 mm)	3/16" to 7/8" (4.8 to 22.2 mm)
25963	25963-0	VACO Step Drill Bit	9	1/16" (1.6 mm)	1/4" to 3/4" (6.4 to 19.1 mm)
25964	25964-7	VACO Step Drill Bit	13	1/32" (0.8 mm)	1/8" to 1/2" (3.2 to 12.7 mm)

Kits

25950	25950-0	VACO 4-Piece All Purpose Step Drill Bit Kit	Includes Cat. Nos. 25960, 25962, 25963, 25964, 1 oz. Bottle Cutting Oil, and Hard Carry Case		
25951	25951-7	VACO 3-Piece Electrician's Step Drill Bit Kit	Includes Cat. Nos. 25960, 25961, 25962, 1 oz. Bottle Cutting Oil, and Hard Carry Case		

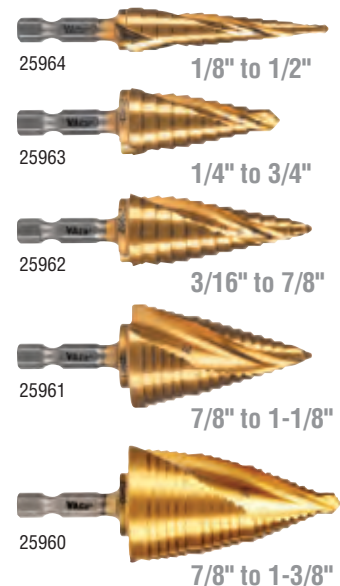

Double-Fluted High-Speed Step Drill Bits

- Two flutes cut faster and keep bit cooler
- Easy-to-read silver step rings save time when drilling common holes
- Fast-starting, non-walking drill tip
- Thick, extra-long 3/8" hex shank provides a firm, positive grip in the drill and won't spin out

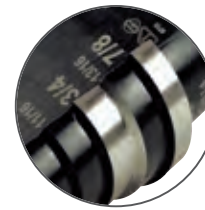

High-visibility silver step rings!



Cat. No.	UPC# 0-92644+	Quick Reference	Number of Holes	Increment	Size
KTSB01	59101-3	#1	13	1/32" (0.8 mm)	1/8" to 1/2" (3.2 to 12.7 mm)
KTSB14	59114-3	#14	12	1/16" (1.6 mm)	3/16" to 7/8" (4.8 to 22.2 mm)
KTSB15	59115-0	#15	3	—	7/8" to 1-3/8" (22.2 to 34.9 mm)

Adjustable Hole Saw

- Quickly and smoothly cuts cleaner holes in drywall and ceiling tiles
- Blades adjust to cut holes from 2" to 7" (5 to 18 cm) in diameter
- Fits most drill chucks 3/8" and 1/2" (0.95 and 1.3 cm) in diameter
- No binding while cutting
- No additional tools needed to adjust the hole saw
- Dust shield catches ceiling debris (2 included)
- Hex-key included

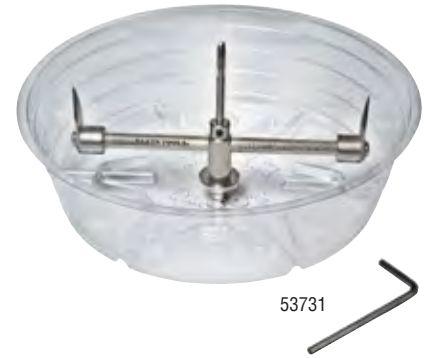

Cat. No.	UPC# 0-92644+	Range
53731	53731-8	2" to 7" (5.1 to 17.8 cm)

Jab Saws

- Cuts drywall, wallboard, plywood and plastic and other construction materials
- Faster cutting blade with triple ground teeth and ability to cut in both directions (push and pull)
- Folding Jab Saw (Cat. No. 31737) is as sturdy as fixed blade jab saws, with a lockback mechanism to secure the blade open at 125° and fully open at 180°
- Hardened, carbon-steel blade for durability
- Hardened, beveled blade point for scoring and plunge cuts
- Comfort cushioned grip handle
- Flat-end grip for palming or punching through drywall



⚠ WARNING: Blades are intended for cutting only, and should be handled and disposed of with care. Bending the blade can cause it to break, possibly resulting in bodily injury. Check local law on legality of selling, possessing, or carrying these knives.

Cat. No.	UPC# 0-92644+	Description	Blade Length	Overall Length
725	31000-3	Jab Saw	6" (15.2 cm)	12" (30.5 cm)
31737	31737-8	Folding Jab Saw	5.2" (13.2 cm)	11.9" (30.3 cm)

High-Tension Hacksaw

- Adjustable blade tension up to 30,000 PSI for fast, precise cuts
- Soft-touch grips
- Alternative 45° mounting for flush cutting
- Front mount for reciprocating saw blades
- Blade storage in handle
- Includes 12" (30.5 cm) x 24 TPI bi-metal hack saw blade and 6" (15.24 cm) x 24 TPI bi-metal reciprocating saw blade

Cat. No.	UPC# 0-92644+	Teeth Per Inch	Blade Length	Overall Length
702-12	70212-9	24	12" (30.5 cm)	16.25" (41.3 cm)



KNIVES



⚠WARNING: Blades are intended for cutting only, and should be handled and disposed of with care. Bending the blade can cause it to break, possibly resulting in bodily injury. Check local law on legality of selling, possessing, or carrying these knives.

Electrician's Bearing-Assisted Open Pocket Knife

- Easy one-handed, bearing-assisted opening
- Drop Point blade
- Strips 14-10 AWG solid, 16-12 AWG stranded wire when the blade is closed
- Hole at the base of the blade for looping wire
- Rugged aluminum handle and a frame lock to secure the blade open
- Ambidextrous flip lever for easy one finger opening
- Low carry pocket clip keeps the knife low in your pocket, yet easy to access
- Lanyard hole for secure tethering



44228



Cat. No.	UPC# 0-92644+	Blade Type	Blade Length	Blade Material	Handle Material	Length Closed	Overall Length
44228	44228-5	Drop Point	2.95" (6.4 cm)	Stainless Steel	Aluminum	4.23" (10.7 cm)	7.18" (18.2 cm)

Assisted-Open Pocket Knives

- Cat. No. 44213 features a bearing-assisted opening mechanism for smooth deployment of the blade and ambidextrous flip-lever for easy one-finger opening
- Cat. No. 44223 features a spring-loaded opening mechanism for quick deployment of the blade, dual thumb studs for both left- and right-hand opening and safety lock keeps blade closed
- Low-carry pocket clip allows the knife to sit low and out of the way
- Lanyard hole for secure tethering
- Blade secures open with a frame lock (Cat. No. 44213) or a liner lock (Cat. No. 44223)



44213



44223

Cat. No.	UPC# 0-92644+	Blade Type	Blade Length	Blade Material	Handle Material	Length Closed	Overall Length
44213	44213-1	Tanto	3.4" (8.6 cm)	420HC Stainless Steel	Stainless Steel	4.6" (11.7 cm)	8.0" (20.3 cm)
44223	44223-0	Half-Serrated Drop Point	3.5" (8.9 cm)	440A Stainless Steel	Anodized Aluminum	4.6" (11.7 cm)	8.1" (20.6 cm)

⚠WARNING: Blades are intended for cutting only, and should be handled and disposed of with care. Bending the blade can cause it to break, possibly resulting in bodily injury. Check local laws on legality of selling or possessing these knives.



Rugged Pocket Knives

- Liner lock secures blade in open position
- Rugged handle with rubber finger grip
- Lanyard hole allows knife to be tethered
- Low-carry pocket clip



44220



44222

Cat. No.	UPC# 0-92644+	Blade Type	Blade Length	Blade Material	Handle Material	Length Closed	Overall Length
44220	44220-9	Drop Point	3.5" (8.9 cm)	440A Stainless Steel	Anodized Aluminum	4.703" (12 cm)	8.203" (20.8 cm)
44222	44222-3	Tanto	3.5" (8.9 cm)	440A Stainless Steel	Nylon/Rubber	4.703" (12 cm)	8.203" (20.8 cm)

Black Aluminum Lockback Knives

- Lockback secures blade in open position
- Black stainless-steel blade and black anodized-aluminum handle
- Reversible thumb stud for easy one-hand opening
- Includes removable pocket clip

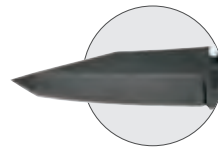

Tanto Blade



44052BLK

Cat. No.	UPC# 0-92644+	Blade Type	Blade Length	Blade Material	Handle Material	Length Closed	Overall Length
44052BLK	44052-6	Tanto	2.563" (6.5 cm)	AUS 8 Stainless-Steel	Anodized Aluminum	3.5" (8.9 cm)	6.125" (15.6 cm)

Camouflage Assisted-Open Folding Utility Knife

- Realtree Xtra® Camo design handle with rubber grip and TPR overmold for a secure grip
- Rugged, heavy-duty and durable construction
- Spring-assisted opening with dual thumb stud for right- or left-handed use
- Blade locks when in closed position
- Low carry pocket clip
- Lanyard hole



44135

Cat. No.	UPC# 0-92644+	Length Closed	Overall Length
44135	44135-6	6.25" (15.9 cm)	7" (17.8 cm)

Realtree Xtra® and Realtree AP-XTRA Camouflage Design is a registered trademark of Jordan Outdoor Enterprises, Ltd.

Folding Utility Knife

- Push button to easily open and close
- Rugged, heavy-duty and durable construction
- Contains a wire stripping notch
- High quality triple ground blades stay sharp longer
- Rubber grips on handle for improved control and comfort
- The bright orange handle color makes this knife easy to find in a tool bag or pouch



44131

Cat. No.	UPC# 0-92644+	Length Closed	Overall Length
44131	44025-0	4" (10.2 cm)	6.25" (15.9 cm)

Auto-Loading Folding Retractable Utility Knife

- Auto-loading blade for faster and safer blade changes
- Internal blade storage holds and includes 3 blades
- Rubber grips on handle for improved control and comfort
- High quality triple ground blades stay sharp longer
- Lock release to close knife
- Equipped with belt clip



44130

Cat. No.	UPC# 0-92644+	Length Closed	Overall Length
44130	44024-3	4.125" (10.5 cm)	7.125" (18.1 cm)

Utility Knife Blades

- Heavy-duty razor-edged blades
- Universal size fits Klein and most other makes of utility knives
- Blades are reversible for extra life
- Blades made in the USA

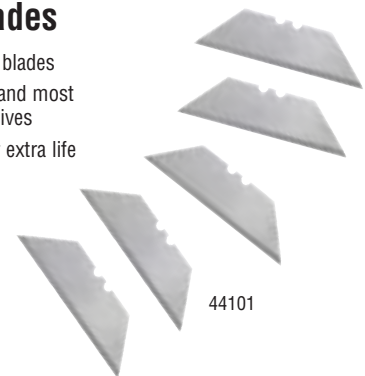

44101

Cat. No.	UPC# 0-92644+	Blade Length	Blade Thickness	Package Quantity
44101	44101-1	2.438" (6.2 cm)	0.025" (0.6 mm)	5

SCREWDRIVERS

Tip-Ident® quickly identifies the type of screwdriver and tip orientation

Core Screwdriver Features

- Heat-treated, premium chrome-plated shank for smooth feel and corrosion resistance
- Precision-machined tip for exact fit
- Integral flanges inside handle provide solid, twist-resistant blade anchor
- Meet or exceed applicable ASME / ANSI specifications

MADE IN USA

Cushion-Grip Screwdrivers and Sets

Includes core Cushion-Grip Screwdriver features plus:

- Narrow cabinet-tip permits blade access where space is limited
- Precision machined combo-tip designed for combination head screws
- Precision machined Phillips tip provides a more consistent geometric symmetry than conventional Phillips screwdrivers to ensure accurate fit and torque without slippage
- Heavy-duty square shank and hex bolster allows wrench-assisted turning
- Bolster reinforces shank for hard use



Cat. No.	UPC# 0-92644+	Tip Type	Shank Type	Insulated	Shank Length	Overall Length
601-6	85014-1	3/16" (4.8 mm) Cabinet	Round	No	6" (15.2 cm)	9.75" (24.8 cm)
603-4	85036-3	#2 Phillips	Round	No	4" (10.2 cm)	8.25" (21 cm)
603-7	85040-0	#2 Phillips	Round	No	7" (17.8 cm)	11.313" (28.7 cm)
Heavy-Duty						
605-6	85046-2	1/4" (6.4 mm) Cabinet	Round	No	6" (15.2 cm)	10.344" (26.3 cm)
Heavy-Duty with Bolster						
600-4	85002-8	1/4" (6.4 mm) Keystone	Square	No	4" (10.2 cm)	8.344" (21.2 cm)
Heavy-Duty with Hex Bolster						
602-6	85024-0	5/16" (7.9 mm) Keystone	Round	No	6" (15.2 cm)	10.938" (27.8 cm)

Color-Coded Cushion-Grip Screwdrivers and Sets

Includes core Cushion-Grip Screwdriver features plus:

- Color-coded handle ends for quick and easy identification
- TORX® tip drive cuts slippage, saves fasteners and transmits more torque to the work



Cat. No.	UPC# 0-92644+	Tip Type	Shank Type	Insulated	Shank Length	Color Code	Overall Length
662	85164-3	#2 Square-Recess	Round	No	4" (10.2 cm)	Red	8.25" (21 cm)
666	85170-4	#2 Square-Recess	Round	No	8" (20.3 cm)	Red	12.25" (31.1 cm)

TORX® is a registered trademark of Acument Intellectual Properties, LLC.

Demolition Screwdrivers and Sets

Includes core Cushion-Grip Screwdriver features plus:

- Engineered, manufactured and tested for prying, chiseling and punching
- Plated metal strike cap to protect handle from hammer blows
- Heat treated metal shaft runs complete length of handle to metal strike cap to transfer metal strike force

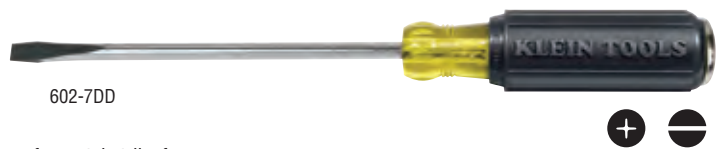

Cat. No.	UPC# 0-92644+	Tip Type	Shank Type	Shank Length	Overall Length
602-4DD	32221-1	1/4" (6.4 mm) Cabinet	Round	4" (10.2 cm)	9" (22.9 cm)
602-7DD	32222-8	5/16" (7.9 mm) Keystone	Round	7" (17.8 cm)	12.375" (31.4 cm)

Terminal Block Screwdriver

Includes core Cushion-Grip Screwdriver features plus:

- Provides exact fit for terminal block screws
- Tip is up to 19% stronger than competitors and provides 76% higher torque value than the required ASME B107 Standard



Cat. No.	UPC# 0-92644+	Tip Type	Shank Type	Shank Length	Overall Length
612-4	32226-6	1/8" (3.2 mm) Cabinet	Round	4" (10.2 cm)	7.75" (19.7 cm)



MULTI-BIT DRIVERS



Multi-Bit Screwdriver/Nut Drivers

- Integrated screwdriver/nut driver shaft holds popular tips and converts nut driver sizes
- Cat. No. 32500MAG features strong, Rare-Earth magnets to securely hold bits and fasteners
- Cat. No. 32527 includes unique style bit for installation/removal of common TR-4 Schrader® valves and aggressive thread extractor tip for backing out broken cores which is great for HVAC and other industrial applications



Cat. No.	UPC# 0-92644+	Description	Nut Driver Sizes	Phillips Bits	Slotted Bits	Square Bits	Hex Bits	TORX® Bits	Other Bits	Shank Length	Overall Length
32500MAG	32488-8	11-in-1 Magnetic	3/8", 5/16", 1/4"	#1, #2	1/4" (6.4 mm), 3/16" (4.8 mm)	#1, #2	—	T10, T15	—	3" (7.6 cm)	7.8" (19.8 cm)
32527	32527-4	11-in-1 w/Schrader®	3/8", 5/16", 1/4"	#1, #2	1/4" (6.4 mm), 3/16" (4.8 mm)	#1, #2	—	—	Schrader® Valve Insertion, Core Removal	3" (7.6 cm)	7.75" (19.7 cm)

TORX® is a registered trademark of Acument Intellectual Properties, LLC.
Schrader® is a registered trademark of Schrader International, Inc.

Multi-Bit Screwdrivers

- On-board storage of industrial strength bits
- Stainless steel bit holders contain powerful Rare-Earth magnets for securing bits and fasteners (Cat. No. 32303, 32308)
- Spin caps for optimum and precise control
- Cushion-Grip handles for greater torque and maximum control
- Available in adjustable length and ratcheting models (Cat. No. 32303, 32304, 32308)
- Collar on Cat. No. 32305 sets ratchet direction at forward, fixed and review
- Impact rated blades can be removed for use with an impact drill (Cat. No. 32303, 32304, 32308)

IMPACT RATED!

Cat. No. 32303, 32304, 32308



Cat. No.	UPC# 0-92644+	Description	Nut Driver Sizes	Phillips Bits	Slotted Bits	Square Bits	Combo Bits	TORX® Bits	Other Bits	Shank Length	Overall Length
32303	32303-4	14-in-1	1/4"	#0, #1, #2, #3	3/16" (4.8 mm), 1/4" (6.4 mm)	#1, #2	#2	T10, T15, T20, T25	—	1" to 4" (2.5 to 10.1 cm)	9.73" (25 cm)
32304	32304-1	14-in-1 HVAC with Flip Socket	1/4", 5/16"	#0, #1, #2	1/8" (3.2 mm), 3/16" (4.8 mm), 1/4" (6.4 mm)	#2	—	T10, T15	#2 JIS Bit, Schrader Valve Insertion Bit, and Core Removal Bit	1" to 4" (2.5 to 10.1 cm)	9.73" (25 cm)
32305	32305-8	15-in-1 Ratcheting	1/4"	#0, #1, #2, #3	3/16" (4.8 mm), 1/4" (6.4 mm)	#1, #2	#1, #2	T10, T15, T20, T25	—	3.5" (8.9 cm)	8.7" (22 cm)
32307	32307-2	27-in-1 Tamperproof	1/4"	—	—	—	—	Tamperproof: T7, T8, T10, T15, T20, T25, T27, T30, T40	TORQ-SET®: TS6, TS8, TS10; Tamperproof Spanner: SP4, SP6, SP8, SP10	3.38" (8.6 cm)	8.5" (22 cm)
32308	32308-9	8-in-1 Stubby	1/4"	#1, #2, #3	3/16" (4.8 mm), 1/4" (6.4 mm)	#1, #2	—	—	—	1" to 2.75" (2.5 to 7 cm)	4.81" (12.2 cm)

*TORQ-SET® is a registered trademark of Phillips Screw Co; TORX® is a registered trademark of Acument Intellectual Properties, LLC.



MULTI-BIT DRIVERS

Ratcheting Multi-Bit Screwdriver/Nut Drivers

- High torque 3-way ratcheting mechanism: forward, reverse and locked positions for tough applications
- Interchangeable shaft holds six universal tips; converts to three nut driver sizes and one hex driver
- Strong, heat-treated nut drivers for improved torque



32593



Cat. No.	UPC# 0-92644+	Description	Nut Driver Sizes	Phillips Bits	Slotted Bits	Square Bits	Hex Bits	Shank Length	Overall Length
32593	32593-9	6-in-1 Ratcheting Stubby	1/4", 5/16"	#1, #2	1/4" (6.4 mm), 3/16" (4.8 mm)	—	—	1.297" (3.3 cm)	3.5" (8.9 cm)

Slide Drive™ Screwdriver/Nut Driver

- Unique, patented Slide Drive™ tip switches from 1/4" size to 5/16" size
- Magnetic regardless of which driver is selected
- Twist the thumb nut to lock tip setting
- U.S. Patent 7,654,175 B2



32596



Cat. No.	UPC# 0-92644+	Nut Driver Sizes	Phillips Bits	Slotted Bits	Other Bits	Shank Length	Overall Length
32596	32596-0	1/4" Magnetic, 5/16" Magnetic, 1/4", 3/8" Hollow	#2	1/8" (3.2 mm), 1/4" (6.4 mm)	Schrader® Valve Insertion/Core Removal	3.25" (8.3 cm)	7.5" (19.1 cm)

Schrader® is a registered trademark of Schrader-Bridgeport International, Inc.



Interchangeable Insulated Screwdrivers

- Securely and easily release the blade with a quick twist of the lock collar
- Interchangeable blades with a slim-tip to fit tight terminal blocks
- Handle and blade have a 1000-Volt insulation rating
- A layer of orange impact and flame resistant insulation protects from electric shock
- Meets or exceeds ASTM F1505 standards for insulation



32286



32288

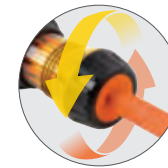

TWIST FOR A FAST, EASY BLADE CHANGE



Cat. No.	UPC# 0-92644+	Description	Tip Size	Shank Length	Overall Length
32286	32286-0	Insulated Flip-Blade	#1 Phillips & 3/16" (4.8 mm) Slotted	3.5" (8.9 cm)	8.2" (20.8 cm)
32287	32287-7	Insulated Flip-Blade	#1, #2 Square	3.5" (8.9 cm)	8.2" (20.8 cm)
32293	32293-8	Insulated Flip-Blade	#2 Phillips & 1/4" (6.4 mm) Slotted	3.5" (8.9 cm)	8.2" (20.8 cm)
13156	13156-1	Single-Ended Replacement Blade, 2-Pack	#2 Phillips & 1/4" (6.4 mm) Slotted	3.5" (8.9 cm)	7.58" (19.3 cm)
13157	13157-8	Double-Ended Replacement Blade, 3-Pack	#1 Phillips & 3/16" (4.8 mm) Slotted, #2 Phillips & 1/4" (6.4 mm) Slotted, #1, #2 Square	3.5" (8.9 cm)	7.48" (19.0 cm)

Interchangeable Screwdriver Set
32288 5-Pc
UPC# 0-92644+ 32288-4
—
—
—
●
●

Set includes handle and carrying pouch.



PRECISION DRIVERS

Core Precision Driver Features

- Spin cap offers optimum and precise control
- Cushion-Grip handle for maximum comfort and torque
- Industrial-strength heat treated bits



All-in-1 Precision Screwdriver Set with Case

Includes core Precision Screwdriver features plus:

- Precision screwdriver set includes 39 bits for various applications including repair of most Apple® products
- Compact case with a stay-shut latch
- Powerful magnets inside barrel to better retain bits, as well as pick up and hold fasteners
- Reversible barrel has standard and extended reach ends



Cat. No.	UPC# 0-92644+	Phillips Bits	Slotted Bits	Square Bits	Hex Bits	TORX® Bits	Other Bits	Shank Length	Overall Length
32717	32717-9	#000, #00, #0, #1, #2	1 mm, 1.5 mm, 2 mm, 2.5 mm, 3 mm, 3.5 mm	#1, #2	0.9 mm, 1.3 mm, 1.5 mm, Tamperproof: 2 mm, 2.5 mm, 3 mm, 3.5 mm	T3, T4, Tamperproof: T5, T6, T7, T8, T9, T10, T15	Triangle: #2, #3; Pentalope: P2, P5; Tri-Wing®: Y000, Y0, Y1; Stand Off; Spanner: #4, #6	Standard: 2" (5.1 cm) Extended: 4" (10.2 cm)	6.35" (16.1 cm)

*Apple® is registered trademarks of Apple Inc; TORX® is a registered trademark of Acument Intellectual Properties, LLC; Tri-Wing® is a registered trademark of Phillips Screw Company.

14-in-1 Precision Screwdriver/Nut Driver

Includes core Precision Screwdriver features plus:

- Precision screwdriver and integrated nut drivers include 14 of the most common sizes in one tool
- Interchangeable steel shaft for fast, easy bit changes
- Sizes are etched into integrated barrels and bits



Cat. No.	UPC# 0-92644+	Nut Driver Sizes	Phillips Bits	Slotted Bits	TORX® Bits	Shank Length	Overall Length
32314	32314-0	9/64", 5/32", 3/16", 7/32", 1/4", 5/16"	#00, #0	3/32" (2.4 mm), 1/8" (3.2 mm)	Tamperproof TT7, TT8, TT10, TT15	3.1" (7.9 cm)	7" (17.8 cm)

TORX® is a registered trademark of Acument Intellectual Properties, LLC.

Multi-Bit Precision Screwdrivers

Includes core Precision Screwdriver features plus:

- Featuring multiple precision bits in one tool
- Cat. Nos. 32613 and 32614 have concealable tips and a pocket clip for easy pocket storage



Cat. No.	UPC# 0-92644+	Description	Phillips Bits	Slotted Bits	TORX® Bits	Other Bits	Shank Length	Overall Length
32613	32613-4	3-in-1 HVAC Pocket	#0	1/8" (3.2 mm)	—	Schrader® Valve Insertion/Core Removal	Long 2.09" (5.3 cm), Short 0.34" (0.9 cm)	6.625" (16.8 cm)
32614	32614-1	4-in-1 Pocket	#0, #00	3/32" (2.4 mm), 1/8" (3.2 mm)	—	—	Long 2.09" (5.3 cm), Short 0.34" (0.9 cm)	6.625" (16.8 cm)

TORX® is a registered trademark of Acument Intellectual Properties, LLC.
Schrader® is a registered trademark of Schrader-Bridgeport International, Inc.



NUT DRIVERS

Impact Flip Sockets

- Patent-pending design with onboard storage
- Quickly and easily change blade between a screwdriver handle and an impact driver
- Multi-function 1/4" socket has both shallow (driver) and deep (bit holder) configurations for added versatility
- Powerful Rare-Earth magnet securely holds bits and hex head fasteners
- Detachable sockets allow for easy removal of metal shavings from magnet
- Features 1/4" Quick-Connect adapter for easy use with an impact driver
- Sockets store on shaft in any order or orientation



Cat. No.	UPC# 0-92644+	Description	Hex Sizes Included
32900	32900-5	7-in-1 Impact Flip Socket	1/4", 5/16", 11/32", 3/8", 7/16", 1/2"
32907	32907-4	7-in-1 Impact Flip Socket Set - No Handle	
32766	32766-7	3-in-1 Impact Flip Socket, 3" (7.6 cm) Length	
32767	32767-4	3-in-1 Impact Flip Socket, 5" (12.7 cm) Length	1/4", 5/16"
32768	32768-1	2-Piece Impact Flip Socket Set (includes 32766/32767)	

Heavy-Duty Cushion-Grip Multi-Bit Nut Drivers

- Multiple sizes in one convenient tool
- Heavy-duty handle and shaft exceed the torque performance of regular nut drivers
- Strong, Rare-Earth magnets securely hold nuts and bolts



Cat. No.	UPC# 0-92644+	Description	Nut Driver Sizes	Shaft Length	Overall Length
32807MAG	32808-4	7-in-1 Nut Driver	1/4", 5/16", 11/32", 3/8", 1/2", 7/16", 9/16"	4" (10.2 cm)	9.54" (24.2 cm)

Heavy-Duty Cushion-Grip Nut Drivers

- Through-handle full-hollow shaft design for torquing hex nuts onto threaded rod of any length
- Color-coded ends and tips for easy size identification
- Wrench-assist for added torque
- Rare-Earth magnetic tip holds nut in place while fastening

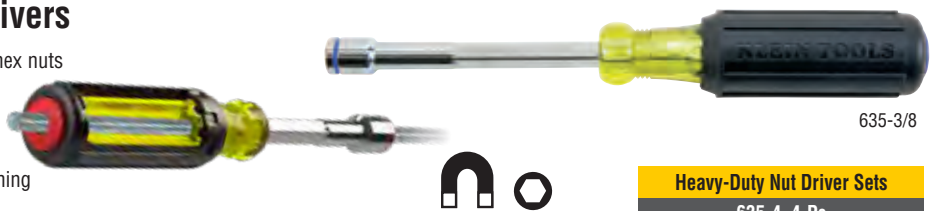

Cat. No.	UPC# 0-92644+	Nut Driver Sizes	Shaft Length	Color Code	Overall Length
635-1/4	32261-7	1/4"	4" (10.2 cm)	Red	9" (22.9 cm)
635-5/16	32262-4	5/16"	4" (10.2 cm)	Yellow	9" (22.9 cm)
635-3/8	32263-1	3/8"	4" (10.2 cm)	Blue	9" (22.9 cm)
635-7/16	32264-8	7/16"	4" (10.2 cm)	Brown	9.391" (23.9 cm)

Heavy-Duty Nut Driver Sets	
635-4 4-Pc	●
UPC# 0-92644+ 32267-9	●
	●
	●

Magnetic-Tip Hollow-Shaft Nut Drivers

Includes core Cushion-Grip Nut Driver features plus:

- Exclusive hollow shaft* design with Rare-Earth magnetic tip features unobstructed pass-through, even on long bolts

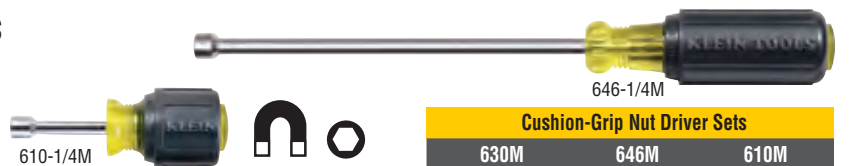

Cat. No.	UPC# 0-92644+	Nut Driver Sizes	Shaft Length	Color Code	Overall Length
610-1/4M	65135-9	1/4"	1.5" (3.8 cm)	Red	3.5" (8.9 cm)
610-5/16M	65136-6	5/16"	1.5" (3.8 cm)	Yellow	3.5" (8.9 cm)
630-1/4M	65137-3	1/4"	3" (7.6 cm)	Red	6.75" (17.2 cm)
630-5/16M	65138-0	5/16"	3" (7.6 cm)	Yellow	6.75" (17.2 cm)
630-11/32M	65205-9	11/32"	3" (7.6 cm)	Green	6.75" (17.2 cm)
646-3/16M	65209-7	3/16"	6" (15.2 cm)	Black	9.75" (24.8 cm)
646-1/4M	65139-7	1/4"	6" (15.2 cm)	Red	9.75" (24.8 cm)
646-5/16M	65140-3	5/16"	6" (15.2 cm)	Yellow	9.75" (24.8 cm)
646-11/32M	65210-3	11/32"	6" (15.2 cm)	Green	9.75" (24.8 cm)
646-3/8M	65211-0	3/8"	6" (15.2 cm)	Blue	9.75" (24.8 cm)
646-7/16M	65212-7	7/16"	6" (15.2 cm)	Brown	10.313" (26.2 cm)

Cushion-Grip Nut Driver Sets		
630M 2-Pc	646M 2-Pc	610M 2-Pc
UPC# 0-92644+ 65144-1	UPC# 0-92644+ 65145-8	UPC# 0-92644+ 65143-4
—	—	●
—	—	●
●	—	—
●	—	—
—	—	—
—	●	—
—	●	—
—	—	—
—	—	—

*3/16" magnetic nut driver does not have a hollow shaft.



ADJUSTABLE WRENCHES

Core Wrench Features

- Precision-machined jaws are individually chosen and assembled by hand for smooth operation
- Standard and metric scales for faster adjustment
- Rail is ground for precision fit
- Minimally protruding jaw shank for greater capacity in tight spaces
- Chrome-plated for corrosion resistance
- 4-threaded knurl worm gear for improved balance

Adjustable Wrenches

Includes core Adjustable Wrench features plus:

- High capacity smaller wrenches handle bigger jobs, especially in confined spaces
- Extra-wide 1/2" (1.27 cm) jaw that provides the same capacity as a standard 12" (30.48 cm) adjustable wrench (Cat. No. D509-8)



D509-8

Cat. No.	UPC# 0-92644+	Jaw Capacity	Handle Color	Handle Finish	Overall Length
High Capacity					
D507-6	67525-6	0.94" (2.4 cm)	Transparent Red	Plastic-Dipped	6.5" (16.5 cm)
D507-8	67528-7	1.125" (2.9 cm)	Transparent Red	Plastic-Dipped	8.25" (21 cm)
D507-10	67531-7	1.3125" (3.3 cm)	Transparent Red	Plastic-Dipped	10.25" (26 cm)
Standard Capacity — Extra-Wide Jaw					
D509-8	19003-2	1.5" (3.8 cm)	Blue	Plastic-Dipped	8.5" (21.6 cm)
Standard Capacity					
D506-4	67501-0	0.5" (1.3 cm)	Transparent Red	Plastic-Dipped	4.5" (11.4 cm)

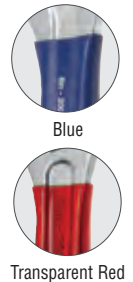

Blue

Transparent Red

Adjustable Wrenches – Slim Jaw

Includes core Adjustable Wrench features plus:

- Designed for tight wrench-over-wrench applications
- Jaws meet ASME 107.11-2010 testing standards for adjustable wrenches while being 40% slimmer than most standard adjustable wrench jaws
- Cat. No. D86936 has 1-1/2" (3.81 cm) extra wide jaw capacity that is 5/16" (0.793 cm) larger than other wide-capacity 8" (20.32 cm) wrenches
- Standard and metric size markings for fast adjustment
- Manufactured for strength and durability



D86936



40% Slimmer Jaw

Cat. No.	UPC# 0-92644+	Jaw Capacity	Handle Color	Handle Finish	Overall Length
D86932	69075-4	0.5" (1.3 cm)	Blue	Plastic-Dipped	4.563" (11.6 cm)
D86934	69076-1	1" (2.5 cm)	Blue	Plastic-Dipped	6.406" (16.3 cm)
D86936	69084-6	1.5" (3.8 cm)	Blue	Plastic-Dipped	8.375" (21.3 cm)

2-in-1 Reversible Adjustable Pipe Wrench

Includes core Adjustable Wrench features plus:

- Versatile 2-in-1 tool converts from adjustable wrench to pipe wrench by reversing the removable jaw
- Reversible jaw has teeth and an obtuse angle to work as a pipe wrench
- Pipe wrench side of jaw grips pipes and round fasteners with self-gripping angled teeth
- 1-1/2" (3.8 cm) extra-wide jaw opening in both configurations
- Standard and metric size markings for fast adjustment
- Meets ASME 107.11-2010 standards for adjustable wrenches



D86930

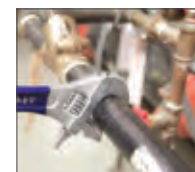

Pipe Wrench

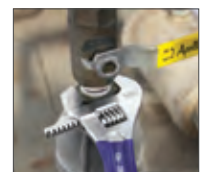

Adjustable Wrench

Cat. No.	UPC# 0-92644+	Jaw Capacity	Handle Color	Handle Finish	Overall Length
D86930	69074-7	1.5" (3.8 cm)	Blue	Plastic-Dipped	10.25" (26 cm)



RATCHET & STRAP WRENCHES

Electrician's Mini Ratchet Set

- Versatile 1/4" dual-drive head and socket adapter
- Ring magnet and bit clip for better bit retention
- Slim profile head for tight spaces
- 72-tooth ratchet makes a small 5° sweep
- Handle loop provides one-hand driving and convenient storage
- Bit holder with a 1/4" adapter and four drive bits

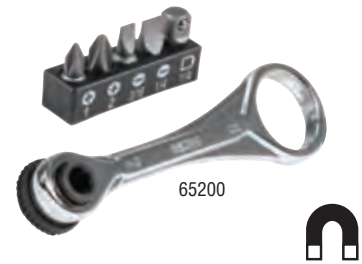

Cat. No.	UPC# 0-92644+	Nut Driver Sizes	Phillips Bits	Slotted Bits	Overall Length
65200	65116-8	1/4", 5/16"	#1, #2	3/16" (4.8 mm), 1/4" (6.4 mm)	4.33" (11 cm)

Ratcheting Refrigeration Wrenches

- Fully reversible for refrigeration-packing gland nuts, valve stem sockets and beam-clamp installation
- Compact in size, with clearly marked sockets for four nut sizes
- Quick-flip reversing lever permits instant ratchet reversal
- Polished chrome finish for smooth edges for comfort



Cat. No.	UPC# 0-92644+	Size	Overall Length		
68310	68298-8	3/16", 5/16" Square x 1/4", 3/8" Square	5.5" (14 cm)		
Additional Items					
Cat. No.	UPC# 0-92644+	Description	Hex Size	Connector Type	Overall Length
86939	69239-0	Adapter for Refrigeration Wrench	3/16", 5/16"	Spring Loaded Ball Bearing	2.125" (5.4 cm)



Grip-It™ Strap Wrenches

- Completely adjustable strap wrench
- Works in the tightest quarters
- Urethane-covered, high-strength belting attached to lightweight, I-beam handle
- Cam-action design permits uniform, high-torque application
- Under normal conditions, will not scratch, damage or deform polished pipe and fittings, plastic pipe and fittings, oil and water filters, glass pipe, PVC conduit, or polished shafts
- Also works on alternator belts, flywheels, and propeller assemblies

Cat. No.	UPC# 0-92644+	Handle Length	Diameter Capacity O.D.
S6HB	69384-7	6" (15.2 cm)	1.5" to 4" (3.8 to 10.2 cm)
S12HB	69385-4	12" (30.5 cm)	1.5" to 5" (3.8 to 12.7 cm)
S18HB	69386-1	18" (45.7 cm)	1.125" to 8" (2.9 to 20.3 cm)
Kit		Kit Includes	
SHBKIT	69387-8	S6HB and S12HB	



HAMMERS

Electrician's Hammers

- High-strength fiberglass core for maximum shock absorption
- Durable, non-slip grip for superior comfort
- H80718 features an engineered claw pulling feature for NMB (Romex®) staple removal
- Hang hole in handle for tethering ability and hanging storage



Cat. No.	UPC# 0-92644+	Type	Feature	Head Weight	Overall Length
H80816	81011-4	Straight-Claw	Tether Hole for Hanging	16 oz (454 g)	12.8" (32.5 cm)
H80820	81012-1	Straight-Claw	Tether Hole for Hanging	20 oz (567 g)	12.8" (32.5 cm)
H80718	81001-5	Straight-Claw	NM-B Staple Pulling; Tether Hole for Hanging	18 oz (510 g)	14.8" (38 cm)
H80332	81013-8	Ball-Peen	Tether Hole for Hanging	32 oz (907 g)	14.9" (38 cm)

Romex® is a registered trademark of Southwire Company.



H80332



H80816

Straight-Claw Hammers

- Straight-claw design for easy nail pulling in tight quarters
- Durable plastic-alloy jacketing helps to protect neck from fraying and splintering if incorrectly struck or overstruck
- High-strength fiberglass shaft absorbs shock and keeps head tight
- Comfortable, perforated neoprene grip bonded to handle

Cat. No.	UPC# 0-92644+	Type	Head Weight	Overall Length
807-18	81004-6	Straight-Claw	18 oz (510 g)	15" (38.1 cm)
808-16	81008-4	Straight-Claw	16 oz (454 g)	13" (33 cm)



807-18

Loose Cable Stapler and Staples

- Drives insulated staples for Voice, Data, Video, NM-B (Romex®) and other nonmetallic (type NM) sheathed cable
- Adjustable to three sizes of staples: 1/4", 5/16", and 19/32"
- Forward action for stability and single-handed operation
- Channel face guides and protects cable
- Cast aluminum body for durability
- Adjustable force setting lever
- Two-level staple guide opening for small and large cable and staple sizes
- Jam resistant mechanism

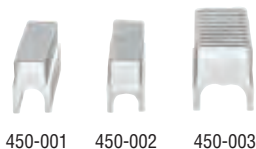

450-001

450-002

450-003

Cat. No.	UPC# 0-92644+	Description
450-100	58327-8	Loose Cable Stapler

Insulated Staples				
Cat. No.	UPC# 0-92644+	Cable Opening Size	Leg Length	For Use With
450-001	58328-5	1/4" x 5/16" (6 mm x 8 mm)	11/16" (17 mm)	• CAT3/5e data cable • Speaker Wire
450-002	58329-2	5/16" x 5/16" (8 mm x 8 mm)		• CAT3/5e/6/6A data cable • RG59/6/6Q coax cable
450-003	58330-8	19/32" x 11/32" (15 mm x 9 mm)	7/8" (22 mm)	• CAT3/5e/6/6A (x2, x3) data cable • RG59/6/6Q (x2) coax cable • NM-B (Romex®) 14-3, 14-3G, 12-3

Romex® is a registered trademark of Southwire Company.



450-100

Utility Staple Starter and Staples

- Heavy-duty, manual staple starter designed to install ground wire and molding on utility poles
- For use with Klein heavy-duty 2" x 1" staples (Cat. No. STP001) as well as current market staples
- Top loading for quick staple reloads and less dropped staples
- Holds up to 35 to 40 staples; enough to finish one pole installation
- Durable steel and aluminum construction for optimal performance
- Bottom stop to prevent driving staples too deep
- Built-in ruler provides an easy way to measure spacing of staples
- Jam release to remove bent staples



STP100

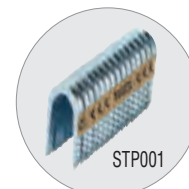

STP001

Staples sold separately

Cat. No.	UPC# 0-92644+	Description
STP100	61011-0	Utility Staple Starter
STP001	61012-7	Collated Staples, packs of 15, total case size of 480 staples



LEVELS & MEASURING



Self-Leveling Cross-Line Laser Level with Red Plumb Spot

- High-performance laser leveling and alignment tool for professionals that provides a reliable self-leveling pendulum
- Horizontal and vertical laser lines and red plumb spot lasers that project horizontal and vertical lines independently or together to address various alignment tasks
- Integrated magnetic 360° mounting bracket with 1/4" and 5/8" (0.6 cm and 1.6 cm) tripod mounting threads
- Low battery indicator and easily accessible battery compartment
- Water and dust resistant (IP54)
- Hard plastic carrying case included



Cat. No.	UPC# 0-92644+	Laser Color	Accuracy	Overall Height	Overall Width	Overall Length
93LCLS	93002-7	Cross-Line: Red; Plumb: Red	±3/32" per 33' (±2 mm per 10 m) Vertical & Horizontal Beams, ±1/8" per 33' (±3 mm per 10 m) Plumb Up Spot, ±5/32" per 33' (±4 mm per 10 m) Plumb Down Spot	5" (12.7 cm)	2.6" (6.6 cm)	5.3" (13.5 cm)
93LCLG	93004-1	Cross Line: Green; Plumb: Red	±3/32" per 33' (±2 mm per 10 m) Vertical & Horizontal Beams, ±1/8" per 33' (±3 mm per 10 m) Plumb Up Spot, ±5/32" per 33' (±4 mm per 10 m) Plumb Down Spot	5" (12.7 cm)	2.6" (6.6 cm)	5.3" (13.5 cm)

Digital Angle Gauge and Level

- This Digital Angle Gauge and Level can measure or set angles, check relative angles, or can be used as a digital level
- High visibility reverse contrast display improves visibility in dimly lit work environments
- Strong magnetic base attaches to conduit, pipes, saw blades, vents, ducts, and other ferromagnetic surfaces
- V-Groove edges enable optimal alignment on conduit and pipes for bending and alignment
- 0 to 90° and 0 to 180° measurement ranges facilitate multiple and diverse applications
- 0 to 180° range is useful when accounting for kickback in pipe bending applications when bending to 90° or more



Cat. No.	UPC# 0-92644+	Accuracy	Overall Height	Overall Width	Overall Length
935DAG	69237-6	±0.1° from 0° to 1°, 89° to 91°, 179° to 180°; ±0.2° at All Other Angles	2.2" (5.6 cm)	1.2" (3 cm)	2.36" (6 cm)

Digital Level with Programmable Angles

- Digital level measures 0 to 90°, 0 to 180°, or dual axis bullseye ranges
- Pre-programmed commonly used target pitches for efficiency and ease-of use: 1/8", 1/4", 3/8" and 1/2" (0.3 cm, 0.6 cm, 0.9 cm, 1.3 cm) per foot
- Easily achieve target angle by setting an audible alarm; LCD will change color as a visual indicator of reaching the set target angle
- Use in bullseye orientation to accurately determine X- and Y-axis
- Display auto-rotates when used in horizontal or vertical orientation
- High visibility reverse contrast display improves visibility in dimly lit work environments



Cat. No.	UPC# 0-92644+	Accuracy	Overall Height	Overall Width	Overall Length
935DAGL	69238-3	Vertical and Horizontal Orientation: ±0.2°; Bullseye Orientation: ±0.5°	2.48" (6.3 cm)	1.36" (3.5 cm)	4.57" (11.6 cm)



LEVELS AND MEASURING

Laser Line Bubble Levels

- Projects a horizontal laser line and spot parallel to the base of the level up to 75' (22.9 m)
- Crisp laser line projects 1/2" (1.3 cm) above base
- Removable leveling base with pin for centering and thumb screws for adjusting the base
- Three easy to read vials identify horizontal and cross at 0° level and vertical at 90°
- The strong magnetic base attaches to ferromagnetic surfaces
- High-visibility orange cast aluminum body is easy to see on conduit and jobsites



LBL100



Cat. No.	UPC# 0-92644+	Number of Vials	Type of Vials	Overall Length
LBL100	69209-3	3	0° Horizontal and Cross, 90° Vertical	7.3" (18.5 cm)

Aluminum Torpedo Levels

- Aluminum frame with orange body for added visibility and durability
- Patented magnet track keeps powerful Rare-Earth magnets in place
- Top V-Groove fits contour of conduit and pipe
- Large high-visibility vials are easy to read



935RBLT



Cat. No.	UPC# 0-92644+	Number of Vials	Type of Vials	Overall Length
935RBLT	93503-9	3	0°, 90°, 45°	9" (22.9 cm)
935RB	93502-2	4	0°, 90°, 45°, 30°	8" (20.3 cm)

Aluminum Torpedo Levels

- Aluminum frame with orange body for added visibility and durability
- Patented magnet track keeps powerful Rare-Earth magnets in place
- Top V-Groove fits contour of conduit and pipe
- Large high-visibility vials are easy to read
- US Patent 9,964,407



935R



Cat. No.	UPC# 0-92644+	Number of Vials	Type of Vials	Overall Length
935R	93501-5	3	0°, 90°, 45°	9" (22.9 cm)

Tape Measures

- Magnetic end hooks with dual angle attraction attaches to conduit and steel studs to easily read from above or below
- Retraction Speed Brake controls blade speed and protects fingers from having to touch blade
- Conduit bending table and 3-phase layout guide helps calculate offsets and saddles
- 13' standout wide, tough, & durable blade
- Uncluttered, easy-to-read bold lines every 1/8"
- Heavy-Duty nylon coating protects blade printing
- Super-sized back clip holds securely to wide belts and extends into pockets



Double Hook End



9216

Cat. No.	UPC# 0-92644+	Tape Length	Hook	Magnetic	Overall Width	Overall Length
9216	69266-6	16' (4.9 m)	Double	Yes	2.35" (6 cm)	3.07" (8 cm)
9225	69269-7	25' (7.6 m)	Double	Yes	2.35" (6 cm)	3.43" (8.7 cm)
9230	69272-7	30' (9.1 m)	Double	Yes	2.35" (6 cm)	3.8" (9.7 cm)

⚠WARNING:

- Protect hands when cleaning magnetic tip end. Use gloves or cloth.
- Avoid magnetic contact with sensitive electronic or computer equipment.
- To avoid personal injury and damage to this tool, do not allow the tape blade to retract into case.
- Do NOT open case. Spring motor is under tension, and opening case may cause injury.

Glow Fish Tape

- Unique Glow-in-the-Dark fiberglass tape and nylon tip
- Fully removable from case for more versatile application such as pass-through wire feeding; alignment mark on case makes for easy re-installation into housing
- Anchoring end utilizes stainless steel connector that is compatible with Klein Fish Rod attachments (see Cat. No. 56511)
- Narrow, eyelet tip for easy feeding through crowded spaces
- Patent pending

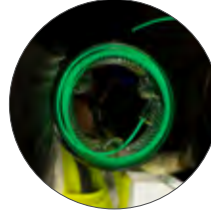

50550

Cat. No.	UPC# 0-92644+	Tape Size	Diameter
50550	50550-8	20' x 0.153" (6.1 m x 3.9 mm)	7.5" (19.1 cm)

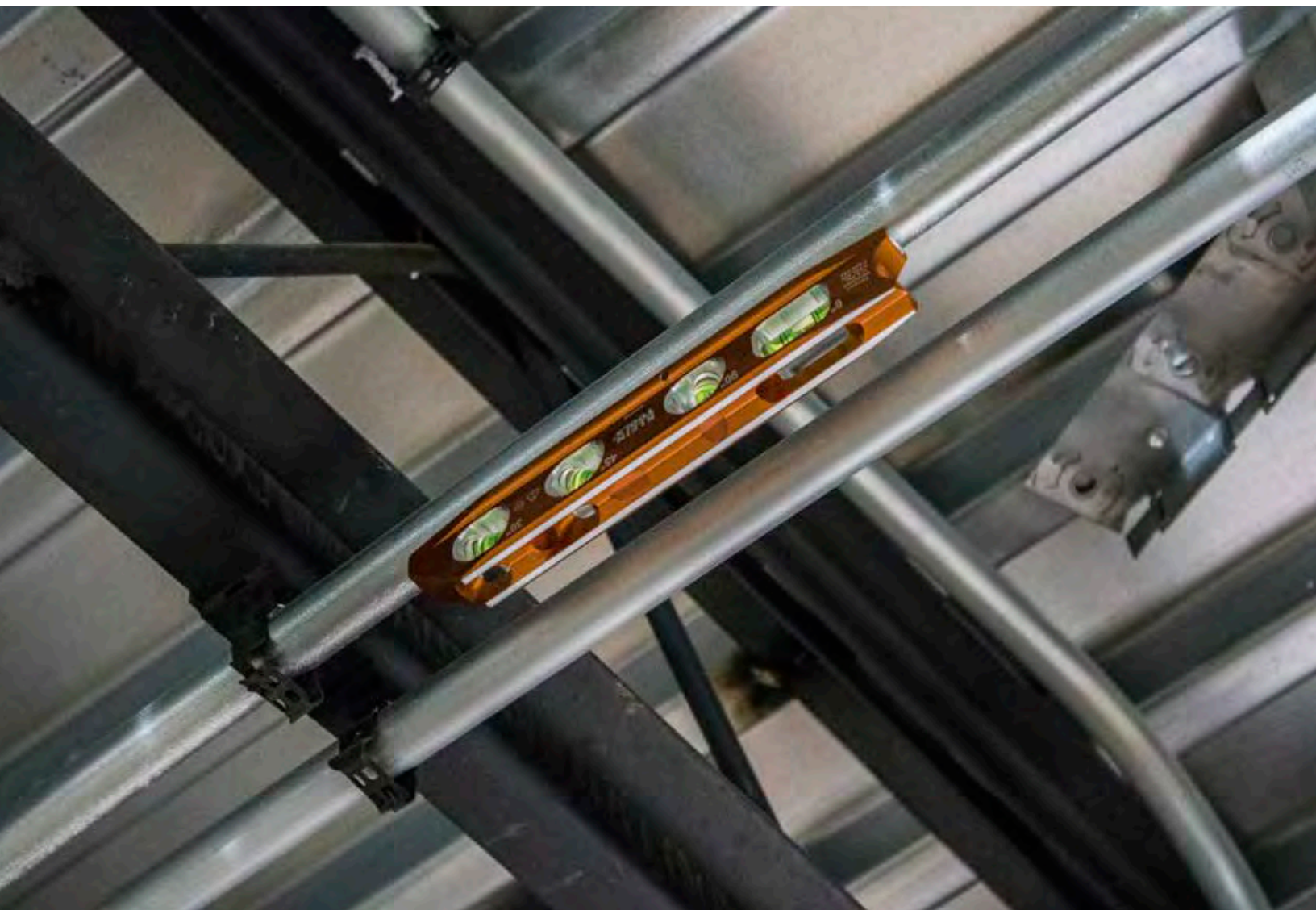

PPE - HARD HATS



Hard Hats

Designed and engineered for optimal safety, comfort and fit.

- Breathable, padded sweat-wicking sweatband and top pad improve comfort and are machine washable
- Patent-pending Accessory Mounts ensure a Klein® Headlamp is properly positioned -on front or back; NO STRAP needed!
- Unique suspension system features a flexible open frame design to provide optimal fit and improved air circulation
- Easy, one-handed adjustment with large knob ratchet mechanism, even with gloves on, and soft neck pad pivots to clear bandanna knots and pony tails
- Sweatband, Top Pad, Chin Strap and Suspension System also sold separately
- All hard hats made of durable PC/ABS



Pivot Adjustment

Allows user to position the ratchet mechanism to clear bandanna knots and pony-tails.

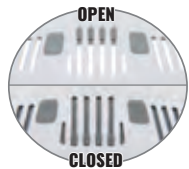

Larger Vents = Better Ventilation

The adjustable vents can be opened or closed for maximum air circulation.



Ratchet Adjustment

Large knob mechanism allows for easy one-hand adjustment, even with gloves on.



Accessory Mounts

Patent-pending accessory mounts ensure the Klein® Headlamp is always properly positioned, on front or back - with NO STRAP needed!

Flexible, Open-Frame Design allows suspension to conform to user's head, provides optimal fit, and improved ventilation.

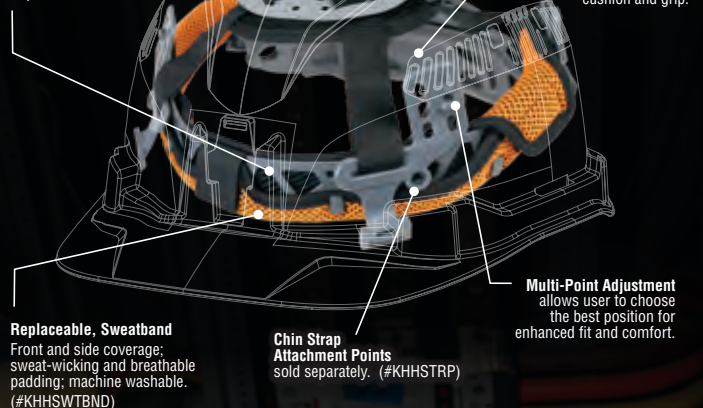

Rear Neck Pad
Soft, non-slip rear pad provides excellent cushion and grip.

Multi-Point Adjustment allows user to choose the best position for enhanced fit and comfort.

Replaceable, Sweatband
Front and side coverage; sweat-wicking and breathable padding; machine washable. (#KHHSWTBND)

Chin Strap Attachment Points sold separately. (#KHHSTRP)



REVERSE DONNING

Suspension can be easily adjusted to wear hard hat frontwards or backwards. Available on both vented and non-vented hard hats.

PROTECTION FROM IMPACT, PENETRATION, AND LATERAL DEFORMATION



Tested to the latest standards

TYPE I, CLASS E
ELECTRICAL PROTECTION
UP TO 20KV

TYPE I, CLASS C
ADJUSTABLE SIDE VENTS HELP
MANAGE AIR CIRCULATION

- 1 ANSI/ISEA Z89.1-2014 CSA Z94.1-15
- 2 EN12492:2012*: 4.2.1.2, 4.2.1.3, 4.2.1.4
- 3 EN397:2012+A1:2012: 5.2.4

*This hard hat provides LIMITED protection from small objects striking the top, front, back, left and right sides of the hard hat. This is NOT an ANSI/CSA Type II hard hat.

Hard Hat with Headlamp

Cat. No.	UPC# 0-92644+	Hat Style	Class	Venting	Shell Color	Headlamp	Lumens	Batteries
60407RL	60428-7	Full Brim	C	Vented	White	Rechargeable	Boost: 300 High: 215 Low: 100	Lithium-Ion



KARBNTM Full Brim Hard Hats

- Stylish, modern, durable hydro-dipped polymer film KARBNTM pattern on rugged PC/ABS composite
- Reflective stickers enhance visibility in low light environments



LOOK COOL; STAY COOL!

Replaceable machine washable, breathable padded **premium sweatband and comfort top pad** feature advanced evaporative technology and additional coverage. Simply wet and shake out for hours of cooling!



Cat. No.	UPC# 0-92644+	Hat Style	Class	Venting	Shell Color	Headlamp	Lumens	Batteries
60347	60347-1	Full Brim	C	Vented	KARBNTM Pattern	Rechargeable (Cat. No. 56048)	All-On: 400 lumen for 4 hrs Spotlight: 200 lumen for 12 hrs Floodlight: 100 lumen for 22 hrs	Lithium-Ion

KARBNTM pattern is a hydro-dipped film applied to PC/ABS composite hard hat surface

PPE - HARD HATS



Safety Helmets

Compact helmet design and unique features allow the user to comfortably work in confined spaces and a variety of demanding environments.

- Patent-pending accessory mounts on front and back ensure Klein® Headlamps (not included) attach securely and precisely — no straps or zip ties needed!
- 6-point suspension along with chin strap provides improved stability and secure fit when tilting your head
- Breathable padded sweat-wicking sweatband and comfort top pad are machine washable
- Easy, one-handed adjustment with large knob ratchet mechanism, even with gloves on; soft neck pad pivots to clear bandanna knots and pony tails
- Detachable 4-point padded chin strap for comfortable secure fit
- Fits hat sizes 6.5 to 8
- Shell: PC/ABS; Suspension: PC/ABS and HDPE



60145



60149



60146



60150

Cat. No.	UPC# 0-92644+	Class	Venting	Shell Color
60145	60145-3	E	Non-Vented	White
60149	60149-1	C	Adjustable Vents	White

Cat. No.	UPC# 0-92644+	Class	Venting	Shell Color	Headlamp	Lumens	Batteries
60146	60146-0	E	Non-Vented	White	Rechargeable (#56062)	Boost: 300 High: 215 Low: 100	Lithium-Ion
60150	60150-7	C	Adjustable Vents	White			



56062

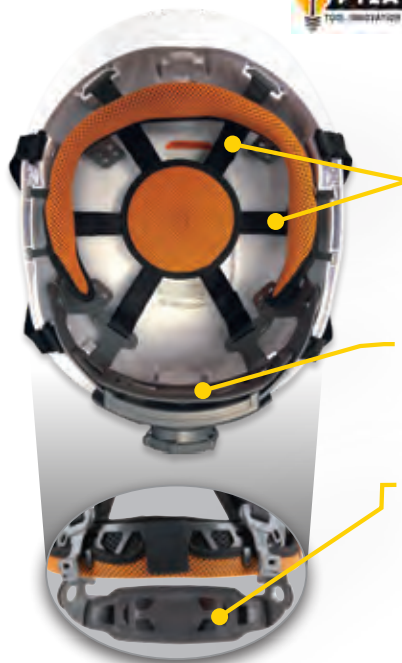

SIX-POINT SUSPENSION
for enhanced stability and secure fit

OPEN-FRAME DESIGN
for maximum air circulation

REAR NECK PAD
made of soft material to conform and grip to maintain ratchet location

PROTECTION FROM IMPACT, PENETRATION, AND LATERAL DEFORMATION

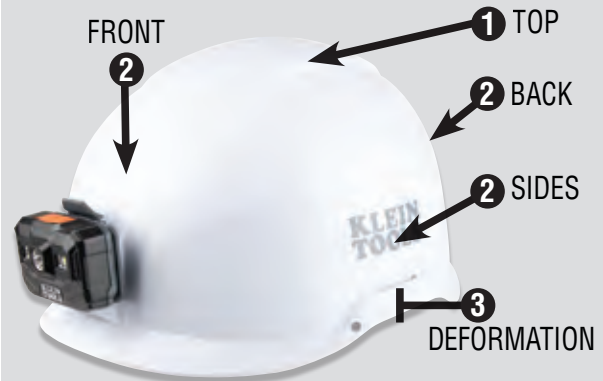

(Shown: Cat. No. 60148: TYPE I, CLASS E)

Tested to the latest standards

TYPE I, CLASS E
ELECTRICAL PROTECTION
UP TO 20KV

TYPE I, CLASS C
ADJUSTABLE SIDE VENTS HELP
MANAGE AIR CIRCULATION

① ANSI/ISEA Z89.1-2014 CSA Z94.1-15

② EN12492:2012*: 4.2.1.2, 4.2.1.3, 4.2.1.4, 4.2.2, 4.2.3, 4.2.4

③ EN397:2012+A1:2012: 5.2.1, 5.2.4, 5.2.5

*This helmet provides LIMITED protection from small objects striking the top, front, back, left and right sides of the helmet. This is NOT an ANSI/CSA Type II helmet.



KARBN™ Safety Helmets

- Large, adjustable vents control air flow in both hot and cold weather (60516, 60517 models only)
- Universal Accessory Slots for hearing protection, face shields and more
- Visor mounting points
- Reflective stickers
- Easy one-handed ratchet size adjustment
- Padded 4-Point detachable chinstrap for secure and comfortable fit
- Patent-pending accessory mounts [front & back] for Klein® Headlamps, Cooling Fan, Safety Lamp



PROTECTION FROM IMPACT AND LATERAL DEFORMATION

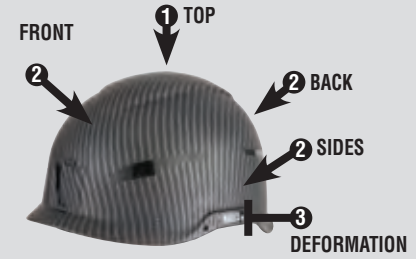

TYPE 1	CLASS E	ELECTRICAL PROTECTION UP TO 20KV
TYPE 1	CLASS C	ADJUSTABLE SIDE VENTS TO CONTROL AIRFLOW

① ANSI/ISEA Z89.1-2014
CSA Z94.1-15

② EN12492:2012:
4.2.1.2, 4.2.1.3, 4.2.1.4, 4.2.2,
4.2.3, 4.2.4

③ EN397:2012+A1:2012:
5.2.1, 5.2.4, 5.2.5

SIX-POINT SUSPENSION FOR ENHANCED STABILITY



EASY ONE-HANDED RATCHET SIZE ADJUSTMENT

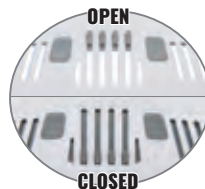

Larger Vents = Better Ventilation
The adjustable vents can be opened or closed for maximum air circulation.

Cat. No.	UPC# 0-92644+	Description	CLASS
60515	60515-4	KARBN™ Safety Helmet w/Rechargeable Headlamp #56062	E
60516	60516-1	KARBN™ Safety Helmet (Vented)	C
60517	60517-8	KARBN™ Safety Helmet (Vented) w/Rechargeable Headlamp #56062	C

Hard Hat/Safety Helmet Cooling Fan

- Dual centrifugal fans feature high and low speed; maintains effective airflow and quiet operation
- Attaches directly to Klein Hard Hats and Safety Helmets' exclusive accessory mounts with no straps needed
- Up to 16 configurations to cool face, neck or under shell



Cat. No.	UPC# 0-92644+	Description
60155	60155-2	Hard Hat/Safety Helmet Cooling Fan

PPE - GEAR



Safety Glasses

High-quality protective eyewear that feature an anti-fog coating that won't wear off. Scratch resistant lenses with UV protection block 99.9% of harmful UV rays.

- Superior impact protection: impact tested to the latest ANSI Z87.1+, CSA Z94.3 and MIL-PRF-32432A Clause 3.8.4.1 (Class 1-ballistics fragmentation) MILITARY STANDARDS
- UV Protection: Tested to ANSI Z87.1 U6 standard, which effectively blocks 99.9% harmful UV rays
- Non-slip fit; rubber nose piece and temple tips for secure fit and grip
- True Color Recognition

MIL-PRF-32432A*
Clause 3.8.4.1
Class 1

CSA
Z94.3

ANSI
Z87.1+



Cat. No.	UPC# 0-92644+	Description	Frame Design	Lens Color
60159	60159-0	Standard Safety Glasses, Clear Lens	Semi-Frame	Clear
60160	60160-6	Standard Safety Glasses, Gray Lens		Gray
60174	60174-3	Standard Safety Glasses-Semi Frame, Combo Pack		Clear / Gray
60470	60470-6	Gasket Safety Glasses with Strap	Full Frame	Clear
60471	60471-3	Gasket Safety Glasses with Strap		Gray

*Does not apply to Gasket Models 60470, 60471

Touch-Screen Work Gloves with Cut-Level Resistance

- Touchscreen-capable fingertips keep you connected on the jobsite
- Nitrile dip technology for superior grip
- Thumb reinforcement for extra protection
- Seamless knit cuff for comfortable fit
- Machine washable



Cat. No.	UPC# 0-92644+	Cut-Level	Standard	Color	Size	Package Quantity
60185	60185-9	2	ANSI A2 Cut Resistance; EN 388: 2015 4342 B	Gray Knit, Black Coating, Orange Cuff Thread	Large (9)	2-Pair
60197	60197-2				Extra-Large (10)	
60186	60186-6	4	ANSI/SEA 105-2016 Cut Level A4; EN 388: 2015 4442 D	High-Visibility Yellow Knit, Black Coating, Orange Cuff Thread	Large (9)	
60198	60198-9				Extra-Large (10)	

JOURNEYMAN™ “Grip” Gloves

- Armortex® rubberized grip on the fingers with reinforced synthetic leather palms and thumb for ample grip in both wet and dry conditions
- D30® padding material in the palm to absorb impact and vibration
- Moisture wicking and breathable TrekDry™ stretch material on top with sponge foam and tricot lining for maximum comfort
- Machine washable
- Flexible yet impact absorbing thermo plastic rubber (TPR) protects the fingers and back of the hand
- Neoprene cuff and soft molded rubber closure with hook and loop secures fit



Cat. No.	UPC# 0-92644+	Size
40215	40215-9	Large
40216	40216-6	Extra-Large

Trek Dry™ is a trademark of Mechanix Wear, Inc.; D30® is a registered trademark of Design Blue Limited; Armortex® is a registered trademark of Nam Liong Enterprise Co. Ltd.

JOURNEYMAN™ Utility Gloves

- Moisture wicking and breathable TrekDry™ stretch material on top with sponge foam and tricot lining for maximum comfort
- Durable synthetic leather palm
- Reinforced thumb and finger panels add protection and durability
- Wide opening elastic cuff for easy entry
- Machine washable



Cat. No.	UPC# 0-92644+	Size
40206	40206-7	Large
40207	40207-4	Extra-Large

TrekDry™ is a trademark of Mechanix Wear, Inc.

Leather Work Gloves

- Genuine professional-grade goatskin leather
- Knuckle and finger protection with PVC guards
- Mesh back for breathability and ergonomic shape for dexterity



Cat. No.	UPC# 0-92644+	Size
60188	60188-0	Large
60189	60189-7	Extra-Large



Thermal Dipped Gloves

- Winter gloves are double dipped and terry lined for protection and warmth in cold weather
- Coated with latex shell for water resistance
- Second coating of textured latex on palm and fingers for superior grip
- Thick lining of 7-Gram brushed acrylic to retain warmth
- Tear and abrasion resistant while still maintaining flexibility for great dexterity
- Ribbed-knit cuff for secure fit
- Machine washable



60389



60390

Cat. No.	UPC# 0-92644+	Standard	Color	Size	Package Quantity
60389	60389-1	EN388-2016 2131X; EN511:2006 X1X	Gray Knit, Black Coating, Orange Trimmed Cuff	Large (9)	1-Pair
60390	60390-7	EN388-2016 2131X; EN511:2006 X1X	Gray Knit, Black Coating, Black Trimmed Cuff	Extra-Large (10)	

Hinged Gel Knee Pads

- Designed with a top strap positioned above the knee to reduce shifting and to keep the knee pad centered
- Lightweight multi-layer pressure absorbing gel padding system provides heavy duty knee support for all-day comfort
- Durable slip-resistant rounded synthetic rubber kneecaps grip work surfaces for ultimate stability while allowing side-to-side mobility
- Adjustable elastic straps allow you to dial in a custom fit and quick-release clips secure upper and lower straps for easy on/off
- Breathable mesh and neoprene lining to keep you cool
- Knee pads are sold in pairs



60344

Cat. No.	UPC# 0-92644+	Overall Length	Overall Height	Overall Width
60344	60344-0	10.7" (27.3 cm)	3.5" (8.9 cm)	9.8" (24.9 cm)

Lightweight and Heavy Duty Knee Pad Sleeves

- Lightweight flexible EVA pad contours leg shape for seamless fit
- Heavy duty triple layer protection with interior neoprene foam padding for all-day comfort
- Can be worn under or over pants
- Second-skin fit allows for agility when in tight spaces
- Elastic cuff with slip-resistant silicone helps knee pads stay in place



60511, 60611



60492, 60592

Cat. No.	UPC# 0-92644+	Knee Pad Sleeves	Size	Measure 6" above center of kneecap	Measure below the center of the kneecap: Lightweight 6" & Heavy Duty 8"
				Thigh Measurement	Calf Measurement
60492	60492-8	Lightweight	M/L	20-21.5" (50.5-54.5 cm)	14.5-16.5" (37-42 cm)
60592	60592-5	Lightweight	L/XL	20.5-23.5" (51.5-60 cm)	15.5-17.5" (39-44.5 cm)
60511	60511-6	Heavy Duty	M/L	20-21.5" (50.5-54.5 cm)	13.5-15.5" (34.5-39.5 cm)
60611	60611-3	Heavy Duty	L/XL	20.5-23.5" (51.5-60 cm)	15-17.5" (38.5-44 cm)

TRADESMAN PRO™ Kneeling Pads

- 1" (2.5 cm) thick, resilient NBR foam protects your knees
- Kneeling pad won't stay compressed, it bounces back to original form
- Chamfered safety edge with orange stripes provides visual and tactile awareness of edge (Cat. No. 60136)



60135

60136

Cat. No.	UPC# 0-92644+	Description	Material	Color	Overall Length	Overall Width	Overall Height
60135	60135-4	Tradesman Pro™ Standard Kneeling Pad	NBR Foam	Black	21" (53.3 cm)	1" (2.5 cm)	14" (35.6 cm)
60136	60136-1	Tradesman Pro™ Large Kneeling Pad	NBR Foam	Black	28" (71.1 cm)	1" (2.5 cm)	16" (40.6 cm)



PPE - WORKWEAR



Cooling Gear

- Activate with water and stays cool for hours
- Wear under hard hats or alone
- Machine washable and reusable



60093



60090



60486



60465



60439



60546



60180



60181

Cat. No.	UPC# 0-92644+	Description	Color	Package Quantity	Special Feature	Size
60093	60093-7	Cooling PVA Towel	Gray	1	Comes in storage tube	13" x 29.5" (33 x 74.9 cm)
60090	60090-6	Cooling PVA Towel	Blue	1	Comes in storage tube	13" x 29.5" (33 x 74.9 cm)
60486	60486-7	Cooling PVA Towel	High-Visibility Yellow	2	Comes in resealable bag with carabiner	13" x 29.5" (33 x 74.9 cm)
60439	60439-3	Neck and Face Cooling Band	Blue	1	Anti-odor and UPF 50+ sun protection	One Size Fits Most
60465	60465-2	Neck and Face Cooling Band	High-Visibility Yellow	1	Anti-odor and UPF 50+ sun protection	One Size Fits Most
60546	60546-8	Cooling Do Rag	High-Visibility Yellow	2	Elastic headband with absorbent terry cloth	One Size Fits Most
60180	60180-4	Cooling Do Rag	Blue	2	Elastic headband with absorbent terry cloth	One Size Fits Most
60181	60181-1	Cooling Helmet Liner	Black	1	Breathable mesh fabric at crown	One Size Fits Most

Warming Gear

- Wear under hard hats or alone
- Machine washable
- One size fits most



Cat. No.	UPC# 0-92644+	Description	Color	Package Quantity	Special Feature	Size	Overall Length
60413	60413-3	Heat Exchanger Balaclava	Black	1	Removable heat exchanger, high-visibility yellow piping	One Size Fits Most	17" (43.2 cm)
60132	60132-3	Wind Proof Hinged Balaclava	Black	1	One-piece with hinge allows for use as a neck gaiter	One Size Fits Most	17.5" (44.5 cm)
60388	60388-4	Heavy Knit Hat, Vintage Patch Logo	Black	1	Extra warmth with heavy knit; vintage Klein Tools logo	One Size Fits Most	10" (25.4 cm)
60391	60391-4	Knit Beanie	Black	1	Fleece lining; high-visibility yellow trim	One Size Fits Most	10" (25.4 cm)
60383	60383-9	Winter Helmet Liner	Black	1	Polar fleece on crown; windproof fabric around ears	One Size Fits Most	11" (27.9 cm)
60466	60466-9	Neck and Face Warming Half-Band	Black	1	Double layered; anti-odor fabric top, fleece bottom	One Size Fits Most	12" (30.5 cm)
60568	60568-0	Heavy Knit Hat, Patch Logo	High-Visibility Yellow	1	Extra warmth with heavy knit; Klein Tools Patch Logo	One Size Fits Most	10" (25.4 cm)
60569	60569-7	Heavy Knit Hat, Leather Logo	Black	1	Extra warmth with heavy knit; Klein Tools Leather Logo	One Size Fits Most	10" (25.4 cm)

High-Visibility Winter Bomber Jacket

- Wind and water resistant with 220-Gram insulation for superior warmth
- ANSI rated Type R, Class 3 with 2-Inch reflective stripes
- Attached inset hood and zippered underarm vents



60364

Cat. No.	UPC# 0-92644+	Chest Size	Color	Number of Pockets	Material
60364	60364-8	Large: 38" to 44" (96.5 to 111.8 cm)	High-Visibility Yellow	10	100% Polyester
60380	60380-8	XL: 44" to 50" (111.8 to 127 cm)			
60501	60501-7	2XL: 50" to 56" (127 to 142.2 cm)			
60612	60612-0	3XL: 56" to 62" (142.2 to 157.5 cm)			

Performance Thermal Socks

- Merino Wool Socks reduce odor and wick-away moisture
- Cushioned foot bed and arch support for all day comfort
- Made in the USA



60508

Cat. No.	UPC# 0-92644+	Shoe Size	Package Quantity	Material	Overall Length
60508	60508-6	Large: Men's Shoe Size 7 to 11	1-Pair	51% Merino Wool, 41% Nylon, 6% Polyester, 2% Lycra Spandex	16.5" (41.9 cm)
60509	60509-3	X-Large: Men's Shoe Size 11.5 to 14			17.5" (44.5 cm)

ILLUMINATION



Handheld Flashlights

Cat. No.	UPC# 0-92644+	Batteries	Drop Protection	Lumens	IP Rating		
Rechargeable Waterproof Pocket Flashlight							
56411	56411-6	Lithium-Ion	10' (3 m)	High: 275 lm - 3 hr Med: 100 lm - 5 hr	Eco: 12 lm - 12 hr Strobe: 15 lm - 47 hr	IP67	
Rechargeable Personal Work Light							
56403	56403-1	Lithium-ion 18650	6' (1.8 m)	High: 460 lm - 9 hr	Low: 175 lm - 16 hr	IP54	
Rechargeable LED Flashlight with Worklight							
56412	56412-3	Lithium-Ion	6' (1.8 m)	Flashlight: 500 lm - 7 hr 315 lm - 10 hr	Worklight: 375 lm - 10 hr 235 lm - 11 hr 35 lm - 30 hr	IP66	
Rechargeable 2-Color LED Flashlight with Holster							
56413	56413-0	Lithium-Ion	6' (1.8 m)	Spotlight: Boost: 1000 lm - 4 hr High: 800 lm - 7hr Strobe: 95 lm - 50hr	Floodlight: High: 650 lm - 6 hr Med: 450 lm - 11 hr Red LED: Solid: 4 lm - 48 hr	Low: 400 lm - 11 hr Eco: 35 - 25 hr Strobe: 4 lm - 96 hr	IP64

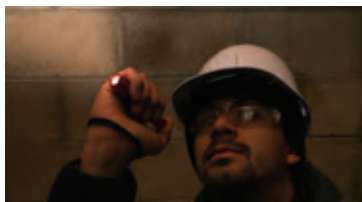

Headlamps

Cat. No.	UPC# 0-92644+	Batteries	Drop Protection	Lumens	IP Rating	
Rechargeable Auto-Off Headlamp with Silicone Strap						
56048	56048-4	Lithium-Ion	6' (1.8 m)	Boost: 400 lm - 4 hr Spotlight: 200 lm - 12 hr	Flood: 100 lm - 22 hr	IP54
Rechargeable 2-Color LED Headlamp						
56414	56414-7	Lithium-Ion	6' (1.8 m)	Spotlight: Boost: 800 lm - 4 hr High: 600 lm - 8hr Strobe: 100 lm - 40hr	Low: 300 lm - 10 hr	IP65
				Floodlight: High: 500 lm - 5 hr Med: 250 lm - 10 hr	Low: 30 lm - 27 hr	
				Red LED: Solid: 2.5 lm - 56 hr Strobe: 2.5 lm - 160 hr		



POWER

PowerHub 1

- 6 surge protected, overcurrent protected, and covered 120V outlets help keep devices powered and electronics protected
- Integral GFCI helps comply with OSHA 1926.404(b)(1) when properly connected and tested
- Elevated 5,000 lumen LED work light rotates from -15 to 75-Degree to illuminate workspaces
- Two USB-A ports and two USB-C ports keep your phones, tablets and electronics charged up and ready to go
- Vertical design saves space on the jobsite and keeps plugs and charging electronics off the ground
- Integrated power cord wrap holds up to 50 feet of 12 AWG cord for easy storage and transport with the PowerHub; power cord not included

Cat. No.	UPC 0-92644+	Description	Lumens	USB Ports	Dimensions
29610	29610-9	PowerHub 1	5000	2x USB-C 2x USB-A	14" x 14" x 25" (35.6 x 35.6 x 63.5 cm)



29610

Portable Power Stations

- Delivers Pure Sine-Wave AC power
- Built-in Lithium-ion battery pack allows for safe indoor use
- Charges and powers multiple devices
 - 505 Wh features two 120V outlets, four USB ports (60W USB-C PD, USB-C and 2 x USB-A) and a 12V car port
 - 983 Wh features four 120V outlets, six USB ports (3 x 60W USB-C PD and 3 x USB-A) and a 12V car port
- Power to run hammer drills, miter saws and more (Cat. No. KTB1000)



KTB1000

No Gas • No Fumes • Just Power

Cat. No.	UPC# 0-92644+	Description	AC Power	Number of Outputs	USB Ports	Recharge Time	Solar Panel (29250) Compatibility	Included
KTB1000	29300-9	Portable Power Station, 983Wh	1500W	11	6	2.5 hrs fast charging (80% charge) 7.5 hrs standard charging (80% charge)	Up to 2 panels	(1) Fast charger, (1) mobile charger, (1) 12V car port adapter
KTB500	29150-0	Portable Power Station, 505Wh	500W	7	4	8-10 hrs standard charging (Full charge)	1 panel	(1) Wall charger, (1) 12V car port adapter

Times and charges are approximate, and not additive, and may vary by application, and ambient environmental conditions.

Solar Panel

- 60-watt foldable solar panel capable of charging power stations, portable batteries and other devices using USB-A, APP® compatible cable, or 8mm DC connectors
- Capability to chain an additional panel (Up to 120W) to collect more solar power and increase charge times
- Kickstands angle the panel to help maximize the surface exposed to the sun and LED lights indicate your level of solar power input
- Two monocrystalline panels fold, creating a protective, compact case for easy storage and versatility
- A long reaching 16.4-Foot (5 m) APP® compatible cable, the APP® compatible to 8mm DC Connector, and the APP® compatible cable all conveniently store in the integrated power pocket

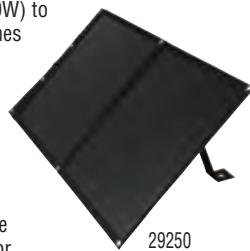

29250

Cat. No.	UPC# 0-92644+	Overall Length	Overall Width	Overall Height	Compatible Products
29250	29250-7	20.5" (52.1 cm)	2" (5.1 cm)	36.5" (92.7 cm)	KTB1000, KTB500

PowerBox 1

- Powerful magnets for attaching to metal job boxes, workbenches, and more
- Integrated LED lights brightens up any job box to locate stored tools, batteries, and cords
- Four 120V AC outlets, two USB-A ports and one 45W PD capable USB-C port for fast charging of cell phones, laptops, and other compatible devices
- Built-in surge protection with LED indicator to protect your equipment from electrical spikes
- Supply power to any metal job box with the 5-Foot durable power cord



29601

Cat. No.	UPC# 0-92644+	Mount	Overall Length	Overall Width	Overall Height
29601	29601-7	Magnetic or Hang holes	5.8" (14.7 cm)	1.8" (4.6 cm)	4.7" (11.9 cm)

Anderson Powerpole® is a registered trademark of Anderson Power Products, Inc.



JOBSITE ACCESSORIES



Rechargeable Personal Jobsite Fan

- Personal fan has multiple mounting options perfect for the job site
- Arm base rotates and cage spins 360° to aim airflow in any direction
- Two powerful magnets and a hang hole are incorporated into the base for mounting
- Base forms a strong clamp for attaching to studs or conduit
- Features two long-lasting fan modes: Low for 9 hours; High for 5 hours



Cat. No.	UPC# 0-92644+	Description	Mounting Type	Battery Life
PJSFM1	29112-8	Rechargeable Personal Jobsite Fan	Magnets, Clamp, Hang Hole, Sit on Base	High 5 hrs, Low 9 hrs

Tradesman Tumbler

- Keeps liquid cold up to 12 hours and hot up to 4 hours
- Designed with double wall vacuum insulated stainless steel
- Rugged, textured silicon outer sleeve for slip-resistance
- Unique threaded lid design allows easy twisting with gloves on or off
- Flip-top lid locks to form a spill-resistant seal
- Removable Rare-Earth magnetic lanyard secures tumbler to metal objects
- Made from stainless steel and other BPA-free food grade materials



Cat. No.	UPC# 0-92644+	Description	Color	Size
55580	55580-0	Tradesman Tumbler	Black/Orange	20 oz (0.59 L)

TRADESMAN PRO™

Tough Box 17-Quart Cooler

- Keeps cool up to 30 hours
- Main compartment has a 17-qt (16.1 L), 18 can capacity
- Shoulder strap holds lid in place while carrying and easily converts to a handle



KEEPS COOL UP TO **30 HOURS** SUPPORTS UP TO **300lb**

Cat. No.	UPC# 0-92644+	Capacity	Number of Compartments	Overall Length	Overall Height	Overall Width
55600	55600-5	17 qt (16.1 L) 18 can	2	12" (30.5 cm)	12" (30.5 cm)	16.203" (41.2 cm)

TRADESMAN PRO™

Soft Lunch Cooler

- Stays cool for up to 12 hours
- Double-thick, leak-resistant anti-microbial liner
- 1680d ballistic weave for durability



KEEPS COOL UP TO **12 HOURS** DOUBLE-THICK LINER

Cat. No.	UPC# 0-92644+	Number of Compartments	Overall Length	Overall Height	Overall Width
55601	55601-2	4	9.5" (24.1 cm)	13" (33 cm)	12" (30.5 cm)



Bluetooth® Jobsite Earbuds

- Noise Reduction Rating (NRR) 28 dB
- Seamlessly stream high-quality stereo audio
- Interchangeable Memory Foam tips provide hearing protection; Silicone tips can be switched out for casual listening
- Easy one-step pairing via trusted Bluetooth® 5.0* up to 33'
- 15-hour total run time (with charging case)
- IP67 rated: dust- and water-proof (earbuds only)
- Included USB-A to USB-C cable for convenient charging

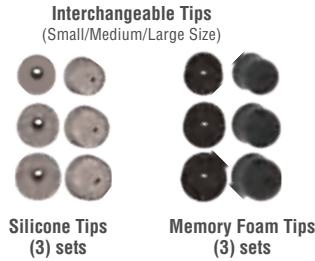

Cat. No.	UPC# 0-92644+	Description	Overall Length	Overall Height	Overall Width
AESEB1	69342-7	Earbuds	0.84" (2.1 cm)	0.96" (2.4 cm)	0.65" (1.7 cm)
		Charging Case	3.15" (8 cm)	1.56" (4 cm)	1.5" (3.9 cm)

Rechargeable Bluetooth® Speaker with Strap

- Rechargeable wireless speaker offers crisp, clean sound and multiple mounting options
- Connects wireless up to 32' (10 m) or via wired auxiliary input (aux cable included)
- Integrated hang hole and versatile magnetic mounting strap
- Hands-free built-in speakerphone
- Rated IP54 dust- and water-resistant; 10' (3 m) drop test
- Includes 1/8" (3.5 mm) auxiliary cable and USB-C -to-standard USB charging cable



Cat. No.	UPC# 0-92644+	Overall Length	Overall Height	Overall Width
AEPJS2	29113-5	4.1" (10.4 cm)	4.2" (10.7 cm)	1.6" (4.0 cm)

Rechargeable Mid-Size Bluetooth® Jobsite Speaker with Magnet & Hook

- Portable Bluetooth® jobsite speaker offers powerful, crisp high-quality sound
- 20 hours of playtime powered by 5200mAh rechargeable li-ion battery
- Conveniently charge smartphones, tablets and other small devices
- Versatile mounting options with embedded magnets for mounting and integrated hook for hanging
- Daisy-chain feature allows pairing of two AEPJS3's together within 30 ft of each other
- Connects wirelessly via Bluetooth up to 100 feet or wired via auxiliary (3.5 mm) cable
- Rugged speaker design features 2m (6.6 ft) drop protection and is IP54 dust- and water-resistant rated
- Built-in microphone allows for hands-free calling via voice control



Cat. No.	UPC# 0-92644+	Overall Length	Overall Height	Overall Width
AEPJS3	69243-7	5.46" (13.9 cm)	5.39" (13.7 cm)	2.34" (5.9 cm)



*Bluetooth® is a registered trademark of Bluetooth Special Interest Group (SIG).

TEST & MEASUREMENT



FEATURES	CL440	CL390
Drop Protection	6.6' (2 m)	6.6' (2 m)
Ingress Protection	-	-
Safety	CAT IV 600V CAT III 1000V	CAT III 600V
AC Voltage (Volts)	1000V	600V
DC Voltage (Volts)	1000V	600V
AC + DC Voltage	●	-
AC Current (Amps)	600A	400A
DC Current (Amps)	-	400A
Ohms (Resistance)	60MΩ	40MΩ
AC Millivolts	-	●
DC Millivolts	●	●
DC Microamps	●	●
True RMS	●	●
Audible Continuity	●	●
Backlight	●	Reverse Contrast Display
Temperature	-40° – 1832°F (-40° – 1000°C)	-40° – 1832°F (-40° – 1000°C)
Low Impedance	●	-
Low-Pass Filter	●	-
Inrush Current	600A	-
Non-Contact Voltage Testing	●	●
Auto Ranging	●	●
Range Hold	●	●
Data Hold	●	●
Diode Test	●	●
Capacitance Test	6000 μF	4000 μF
Frequency / Duty Cycle	10Hz – 1MHz	10Hz – 60kHz
Max / Min	●	●
Relative Mode	●	●
Magnetic Mount	Available As Accessory	Available As Accessory
Worklight	-	-
Auto-Power Off	●	●
LCD Display Count	6000	4000



	CL440 UPC# 0-92644+ 69335-9	CL390 UPC# 0-92644+ 69287-1
	<ul style="list-style-type: none"> Auto-ranging True root mean square (TRMS) 600A AC current AC/DC voltage DC Microamps DC Millivolts Resistance Continuity Frequency Duty cycle Capacitance Tests diodes Inrush Current Temperature Low Pass Filter Non-Contact Voltage Testing 	<ul style="list-style-type: none"> Auto-ranging True root mean square (TRMS) 400A AC/DC current AC/DC voltage AC/DC Millivolts DC Microamps Resistance Continuity Frequency Duty cycle Capacitance Tests diodes Temperature Non-Contact Voltage Testing
Included	<ul style="list-style-type: none"> Carrying Case Instruction Manual Test Leads with CATIII/CAT IV safety caps (2) K-Type thermocouples (3) AAA Batteries 	<ul style="list-style-type: none"> Carrying Case Instruction Manual Test Leads with CATIII/CAT IV safety caps Thermocouple (3) AAA Batteries
Jaw Size	2.00" (5.1 cm)	1.6" (4.1 cm)
Overall Length	10.04" (25.5 cm)	8.45" (21.5 cm)
Overall Width	3.77" (9.6 cm)	3.5" (8.9 cm)
Overall Height	1.57" (4.0 cm)	1.5" (3.8 cm)
Weight	14.2 oz (40 g)	11 oz (314 g)





MM720 UPC# 0-92644+ 69376-2	MM420 UPC# 0-92644+ 69374-8	MM325 UPC# 0-92644+ 69373-1
-----------------------------------	-----------------------------------	-----------------------------------

- | | | |
|--|---|--|
| <ul style="list-style-type: none"> • Auto-ranging • True root mean square (TRMS) • Reverse contrast display • Optically Controlled Backlight • AC/DC Voltage • AC/DC Current • Resistance • Continuity • Temperature • Capacitance • Frequency • Low impedance functionality • Features an LCD version of the Lead Alert function | <ul style="list-style-type: none"> • Auto-ranging • True root mean square (TRMS) • Backlight • AC/DC voltage • AC/DC current • Resistance • Continuity • Temperature • Capacitance • Frequency • Features Lead Alert LED's | <ul style="list-style-type: none"> • Manual-ranging • Backlight • AC/DC voltage • DC current • Resistance • Continuity • Battery Test • Lead Alert LED's |
|--|---|--|

Included	<ul style="list-style-type: none"> • Carrying Case • Instruction Manual • Test Leads with CATIII/CAT IV safety caps • Thermocouple • (2) AAA Batteries 	<ul style="list-style-type: none"> • Instruction Manual • Test Leads with CATIII/CAT IV safety caps • Thermocouple • (2) AAA Batteries 	<ul style="list-style-type: none"> • Instruction Manual • Test Leads with CATIII/CAT IV safety caps • (2) AAA Batteries
Standard	CAT IV 600V CAT III 1000V	CAT III 600V	CAT III 600V
Overall Length	6.94" (17.6 cm)	6" (15.2 cm)	6.41" (16.2 cm)
Overall Width	3.37" (8.5 cm)	3.16" (8 cm)	3.13" (7.9 cm)
Overall Depth	1.88" (4.7 cm)	1.78" (4.5 cm)	1.83" (4.6 cm)
Weight	12.2 oz (345 g)	8.2 oz (231 g)	8.8 oz (250 g)

FEATURES	MM720	MM420	MM325
Drop Protection	6.6' (2 m)	6.6' (2 m)	6.6' (2 m)
Ingress Protection	IP42	—	—
Safety	CAT IV 600V CAT III 1000V	CAT III 600V	CAT III 600V
AC Voltage (Volts)	1000V	600V	600V
DC Voltage (Volts)	1000V	600V	600V
AC Current (Amps)	10A	10A	—
DC Current (Amps)	10A	10A	10A
Ohms (Resistance)	60MΩ	50MΩ	2MΩ
DC Millivolts	●	●	●
AC Milliamperes	●	●	—
DC Milliamperes	●	●	●
AC Microamperes	●	●	—
DC Microamperes	●	●	●
True RMS	●	●	—
Audible Continuity	●	●	●
Backlight	Reverse-Contrast Optical Sensor	●	●
Temperature	-40° – 1832°F (-40° – 1000°C)	-40° – 1832°F (-40° – 1000°C)	—
Low Impedance	●	—	—
Auto Ranging	●	●	—
Range Hold	●	●	—
Data Hold	●	●	●
Diode Test	●	●	●
Capacitance Test	6000 μF	400 μF	—
Frequency / Duty Cycle	1Hz – 500 KHz	1Hz – 50 KHz	—
Max / Min	●	●	—
Lead Warning	On LCD	Green LED's	Green LED's
Magnetic Mount	Available As Accessory	Available As Accessory	Available As Accessory
Auto-Power Off	●	●	●
Battery Test	—	—	●
LCD Display Count	6000	4000	2000



TEST & MEASUREMENT



FEATURES	ET600 UPC# 0-92644+ 69242-0	FEATURES	ET600 UPC# 0-92644+ 69242-0
Drop Protection	3.3' (1 m)	Audible Continuity	●
Ingress Protection	—	Backlight	●
Safety	CAT IV 600V CAT III 1000V	Auto Ranging	●
Test Voltages	125V, 250V, 500V, 1000V	Test Lock	●
AC Voltage (Volts)	1000V	Data Hold	●
DC Voltage (Volts)	1000V	Max / Min	●
Insulation Resistance	4000MΩ	Bar Graph	●
Ohms (Resistance)	4kΩ	Auto-Zero	●
Live Circuit Detection	●	Magnetic Mount	Available As Accessory
True RMS	●	Auto-Power Off	●
Over-Range Indication	●	LCD Display Count	4000

Insulation Resistance Tester

- Test insulation resistance up to 4000MΩ at 125V, 250V, 500V, and 1000V DC
- Test and Lock buttons for simple insulation testing
- Warning alarm and high voltage icon for detection of voltage
- Measures up to 1000V AC/DC, low resistance, and continuity
- Automatic ranging True root mean square (TRMS) technology for increased accuracy
- Backlit display with bar graph, Auto-power off, High Voltage, Max/Min, and Hold icons
- Low battery indicator with easily replaceable battery and fuse
- Built-in stand and optional magnetic hanger for hands free operation
- Test verification of conformity to EN61557-1,-2,-4
- CAT IV 600V and CAT III 1000V safety rating
- Includes CAT III/CAT IV Safety Rated Test Leads, Heavy-duty Alligator Clip Test Leads, Batteries, Carrying Case, and Instruction Manual



NCVT-2P



NCVT-3P



NCVT-4IR



Features	NCVT-2P UPC# 0-92644+ 69232-1	NCVT-3P UPC# 0-92644+ 69323-6	NCVT-4IR UPC# 0-92644+ 69061-7
Drop Protection	6.6' (2 m)	6.6' (2 m)	6.6' (2 m)
Ingress Protection	IP54	IP67	IP54
Safety and Standards	CAT IV 1000V	CAT IV 1000V	CAT IV 1000V
Voltage	Range 1: 12-1000V AC Range 2: 70-1000V AC	Range 1: 12-1000V AC Range 2: 70-1000V AC	12-1000V AC
Frequency Range	50-500Hz	50-500Hz	50-500Hz
Audible and Visual Alarms	●	●	●
Auto-Power Off	●	●	●
Temperature	—	—	-22° – 482°F (-30° – 250°C)
Laser	—	—	Class 2
Flashlight	—	●	—
Backlight	—	—	●
LCD Display	—	—	Backlight
Batteries	2 x AAA	2 x AAA	2 x AAA
Overall Length	5.82" (14.8 cm)	5.70" (14.5 cm)	6.25" (15.9 cm)
Overall Height	0.86" (2.2 cm)	0.93" (2.4 cm)	1.19" (3 cm)
Overall Width	1.09" (2.8 cm)	1.09" (2.8 cm)	1.25" (3.2 cm)

Non-Contact Voltage Testers

- CAT IV safety rating
- Auto power-off
- Convenient pocket clip
- Does not detect DC voltage
- **NCVT-2P** is a dual range non-contact voltage tester. The NCVT detects voltage from 70 to 1000V AV (in Range 1) or 12 to 1000V AC (in Range 2). Updated screw-cap battery compartment, heavy-duty pocket clip, and recessed buttons increase product durability. Enhanced LED interface makes the product easy-to-understand; light indicator clearly marks range being used for testing.
- **NCVT-3P** is a dual range non-contact voltage tester with an integrated flashlight that can be used independent of the voltage detection function. The NCVT can be set to detect voltage from 70 to 1000V AV (in Range 1) or 12 to 1000V AC (in Range 2). Enhanced LED interface makes the product easy-to-understand; light indicator clearly marks range being used for testing.
- **NCVT-4IR** is designed for HVAC applications and hot spots in panels, includes an infrared thermometer with selectable °F/°C from -20° to 482°F (-30° to 250°C), LCD backlit display, and convenient laser pointer to help target 4:1 distance to spot ratio for temperature.



Rechargeable Thermal Imager

- Thermal Imager has over 10,000 pixels to troubleshoot hot and cold spots
- Adjustable emissivity from 0.10 to 0.99
- Store and share images with optional microSD® Card
- User selectable high and low temperature alarms from -4 to 752° Fahrenheit (-20 to 400° Celsius)
- Select color palettes to best capture the event
- Rechargeable lithium-ion battery
- Includes thermal imager, micro-USB charging cable, carrying case, and instructions



TI250

Cat. No.	UPC#	Description	Display	Display Resolution	Temperature Range	Batteries
TI250	69293-2	Rechargeable Thermal Imager	2.4" (6.1 cm) TFT LCD	10,800 Pixels	-4° to 752°F (-20° to 400°C)	Lithium-Ion



microSD® is a registered trademark of SD-3C, LLC.

Thermal Imagers for Mobile Devices

- Thermal Imager for iOS and Android® Devices has 10,800 pixels to deliver excellent resolution for troubleshooting hot and cold spots
- Thermal Imager for iOS fits phone cases up to 1/16" (1.5 mm); phone cases thicker than 1/16" (1.5 mm) may require removal of case for secure connection
- Easily capture, store and share thermal images and video, including time-lapse video
- Features touch screen temperature, high/low temperatures, and differential temperature readout
- View temperature ranges from -4° to 752° F (-20° to 400° C) in three color palettes; ironbow, rainbow, or grayscale
- Includes high/low temperature alarms to monitor systems
- Compatible with iOS devices 11 and higher (Cat. No. TI222)
- Compatible with most Android® devices versions 6.0 or higher with USB-C or Micro-USB connectors (Cat. No. TI220)
- Klein Tools Thermal Imager App and Thermal Imager Android® App is available for free in the App Store and Google Play™ store
- Durable 6.6' (2 m) drop test protection

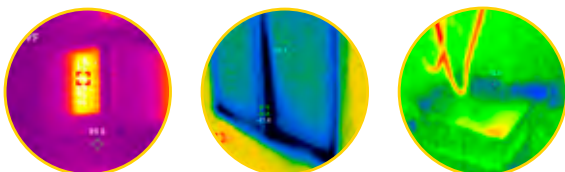
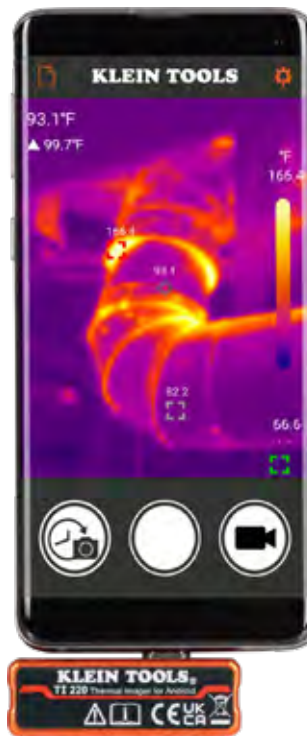

Easily capture, store, and share thermal images and video using the Klein Tools Thermal Imager App. Available for free on Google Play™ Store or App Store®.



Cat. No.	UPC	Description	Compatibility	Mobile App
TI220	69348-9	Thermal Imager for Android® Devices	Android® 6.0 or higher	Google Play™ Store
TI222	69361-8	Thermal Imager for iOS Devices	iOS 11 or higher with Lightning connectors	App Store®

Android® is a registered trademark of Google LLC. Google Play™ store is a trademark of Google LLC. App Store®, iPhone, and Lightning are registered trademarks of Apple Inc., registered in the U.S. and other countries. iOS is a trademark or registered trademark of Cisco in the U.S. and other countries and is used by Apple, Inc. under license.



TEST & MEASUREMENT

Digital Differential Manometer

- Measures air and gas pressure for ports P1, P2, and differential
- Range of +/- 60 inH₂O and full scale accuracy of +/-1.5%
- Strong magnet on back for hands-free operation
- Units measured: inH₂O, bar, oz/in², psi, mbar, kPa, inHg, mmHg, kg/cm², ftH₂O, and cmH₂O
- Calculates minimum, maximum and average values
- Includes 6.56' (2 m) x 1/8" (3 mm) inside diameter silicon tubing, 3 x AAA batteries, pouch, instruction manual



Cat. No.	UPC	Batteries	Overall Length	Overall Height	Overall Width
ET180	69336-6	3 x AAA	2.47" (6.3 cm)	6.19" (15.7 cm)	1.38" (3.5 cm)



ET180

Borescope for Android® Devices

- Borescope connects to Android® on-the-go (OTG) version 4.0 or higher devices; NOT for iPhones® or iPads®
- Waterproof IP67 9 mm camera surrounded by 6 LEDs for high quality 640 x 480 pixel images
- Capture and share images and video via text or email using the Klein Tools App available for download at Google Play®
- Armored 10' (3 m) gooseneck cable for extended reach
- Direct USB Type-C connection with adapter for micro-USB



ET16



Turn your smartphone into a smart tool

Cat. No.	UPC	Screen Resolution	Included
ET16	69298-7	640 x 480 max pixels	Borescope with 10' Gooseneck, USB Adapters, Carrying Case, and Instruction Manual
Overall Height	Overall Width	Overall Length	
0.95" (2.4 cm)	1.3" (3.3 cm)	3.7" (9.4 cm)	

Google Play® and Android® are registered trademarks of Google LLC. Apple®, iPhone® and App Store® are registered trademarks of Apple Inc

WiFi Borescope

- WiFi Borescope transmits and displays video and images directly to your smartphone up to 30' (9 m) away
- Waterproof 9 mm camera has 6 on-board, adjustable LED lights and outputs high-quality 640 x 480 images
- Tough, armored 6' (1.8 m) long waterproof camera gooseneck maneuvers around obstacles while maintaining rigidity
- Battery status indicator tracks the charge level of the lithium-ion battery
- Increase and decrease camera LED output either on the Borescope or in the App
- The App not only acts as a display, but stores and shares images and videos via text or email
- Includes convenient pocket clip, USB charging cable, hook attachment, carrying case, and instructions
- The Klein Borescope App is available free at the App Store® for iPhone® users and Google Play® for Android® users



Turn your smartphone into a smart tool



ET20



Cat. No.	UPC	Battery Life	Ingress Protection	Drop Rating
ET20	69231-4	5.5 Hours	Camera/cable: IP67; Body: IP42	9.8" (3 m)
Overall Width	Overall Height	Overall Length		
1.5" (3.8 cm)	2.3" (5.8 cm)	7.3" (18.5 cm)		

Google Play® and Android® are registered trademarks of Google LLC. Apple®, iPhone® and App Store® are registered trademarks of Apple Inc



Digital Pocket Thermometers

- User selectable Fahrenheit and Celsius temperature measurements
- Backlit display for easy viewing in low light
- Max/Min, Hold and Average functions
- Auto-power off after 15 minutes conserves battery life
- FDA GRAS compliant for food usage
- Lightweight, compact tool with pocket clip provides easy storage and quick access
- Cat. No. ET05 has a range of -40° to 482° F (-40° to 250° C); Cat. No. ET10 has a range of -40° to 572° F (-40° to 300° C)
- Cat. No. ET10 features a magnet inside base of probe to easily attach to vents for hand-free IAQ (indoor air quality) measurements



ET10
(Protective sheath positioned as handle)



Cat. No.	UPC 0-92644+	Batteries	Overall Length
ET05	69060-0	2 x LR44	6.50" (16.5 cm)
ET10	69145-4	2 x LR44	6.50" (16.5 cm)

Dual IR/Probe Thermometer

- Measure temperature from -40 to 572°F (-40 to 300°C)
- Accurately measure surface temperature with Infrared Thermometer (DS ratio 8:1)
- Temperature probe also can measure liquid temperatures



IR07



Cat. No.	UPC 0-92644+	Distance to Spot	Range	Batteries	Includes
IR07	69181-2	8:1	-40° to 572°F (-40° to 300°C)	(2) AAA	Thermometer, batteries, pouch

Not a medical device; thermometer is NOT intended for use on people or animals.

Dual-Laser Infrared Thermometer, 20:1

- Incorporates surface temperature measurement capability using IR emission and can also measure bulk temperatures of air, gas, or liquids using a standard K-Type probe
- Dual targeting lasers offer more accurate determination of the area being tested
- Optical Resolution (Distance-to-Spot) is 20:1



IR10



Cat. No.	UPC 0-92644+	Distance to Spot	Range	Batteries	Includes
IR10	69185-0	20:1	-40° to 1200°F (-40° to 650°C)	(1) 9V	Thermometer, battery, K-Type probe, pouch

Not a medical device; thermometer is NOT intended for use on people or animals.

Carbon Monoxide Meter

- Easy-to-use meter detects and measures concentration levels of carbon monoxide gas in ambient air
- User protection with short-term exposure limit (STEL) alarms: low level alarm (35 ppm) and high level alarm (200 ppm)
- Backlit display with CO measurement (0 to 1000 ppm) and temperature (°F and °C)
- Auto-power off after 20 minutes of no usage helps conserve battery life
- Includes carrying pouch, instruction manual, and 4 x AAA batteries



Cat. No.	UPC 0-92644+	Batteries
ET110	69065-5	4 x AAA

Meter is not intended for use as personal protection equipment



ET110



TEST & MEASUREMENT

Refrigerant Gas Leak Detector

- Refrigerant gas leak detection of CFCs, HFCs, HCFCs, and blends from 100 ppm to 3000 ppm
- 18" (45.7 cm) gooseneck probe for easy access around equipment
- Visual and audible alarms increase with refrigerant gas concentration
- High (100 to 1000 ppm) and low (200 to 3000 ppm) levels of sensitivity settings; based on R-134A
- Automatic zero-point calibration at power-up
- Includes 4 x AAA batteries, storage pouch, and instructions



ET160



Cat. No.	UPC 0-92644+	Batteries
ET160	69337-3	4 x AAA

Meter is not intended for use as personal protection equipment

Combustible Gas Leak Detector

- Select from two levels of sensitivity: High (50 to 1000 ppm) and Low (50 to 10,000 ppm)
- Measures methane, propane, butane, and other gases to detect for leaks
- Five red LEDs (visual) and 85db audible alerts that increase with gas concentration to detect the gas leak
- Automatic zero-point calibration at power-up
- 18" flexible gooseneck expands sensor's reach; clips onto device for storage
- Auto power-off after 10 minutes of non-usage conserves battery life
- Includes carrying pouch, instruction manual, and 4 x AAA batteries



ET120



Cat. No.	UPC 0-92644+	Batteries
ET120	69064-8	4 x AAA

Meter is not intended for use as personal protection equipment

K-Type Temperature Pipe Clamp

- Features a temperature sensor that clamps around pipes ranging from 1/4" to 1-3/8" diameter (up to 3.5 cm)
- A flexible 40" (102 cm) lead
- Works with any clamp or multimeter that measures temperature
- Includes banana plug adapter



69140

Cat. No.	UPC 0-92644+	Overall Length	Overall Height	Overall Width	Temperature Range
69140	69067-9	5.25" (13.3 cm)	0.75" (1.9 cm)	3.00" (7.6 cm)	-4 to 212°F (-20 to 100°C)

K-Type Thermocouple Probe

- Pointed tip easily pierces fiberglass ductwork for HVAC measurements
- A coiled 5' (1.5 m) lead
- Wide measurement range: -58 to 1112°F
- Works with any clamp or multimeter that measures temperature
- Includes banana plug adapter



69144

Cat. No.	UPC 0-92644+	Overall Length	Overall Height	Overall Width	Temperature Range
69144	69069-3	12.50" (31.8 cm)	0.50" (1.3 cm)	0.50" (1.3 cm)	-58 to 1112°F (-50 to 600°C)

Replacement K-Type Thermocouples

- UL® listed replacement thermocouple with banana plug connector 0° to 250°C (Cat. No. 69028)
- Measurement range of 0° to 250°C (Cat. No. 69435)
- Temperature measurement range of 0 to 480°C and includes banana plug adapter (Cat. No. 69142)
- Allows K-Type temperature thermocouples to be used with a meter with banana plug ports (Cat. No. 69146)



69028



69142



69146



69435

Cat. No.	UPC 0-92644+	Type	For Use With
69028	69028-0	K-Type Banana Thermocouple	CL220, CL320, CL390, CL700, CL800, MM400, MM600, MM700, and some older models
69435	69230-7	K-Type Thermocouple	Any Clamp or Digital Multimeter that Measures Temperature
69142	69068-6	K-Type Thermocouple, High Temperature with Adapter	Any Clamp or Digital Multimeter that Measures Temperature
69146	69070-9	K-Type Banana Plug Adapter	Any Clamp or Digital Multimeter that Measures Temperature

*UL and the UL logo are trademarks of UL LLC © 2020



Rare-Earth Magnetic Hangers

- Magnetic Hangers allow the user to safely work hands-free
- Constructed with powerful Rare-Earth magnets
- Durable nylon weave resists wear and tear and clips securely into back of meter (Cat. No. 69417)
- Securely clips onto the back of the meter with no strap (Cat. No. 69445)



Cat. No.	UPC 0-92644+	Description	For Use With
69417	69417-2	Rare-Earth Magnetic Hanger, with Strap	CL120, CL220, CL320, CL390, CL600, CL700, CL800, CL900, ET600, MM325, MM420, MM720, and some older models
69445	69288-8	Rare-Earth Magnetic Hanger, no Strap	

Replacement Test Leads

- Safety Rating: Category IV 600V and CAT III 1000V
- Intended for use as replacement test leads for meters that have standard, banana-type input jacks
- Leads perform accurately with Klein Tools' meters and other manufacturer's meters
- Screw-on alligator clips attach to wires and other conductors (Cat. No. 69410)
- Perfect for insulation resistance testing (Cat. Nos. 69831 and 69367)

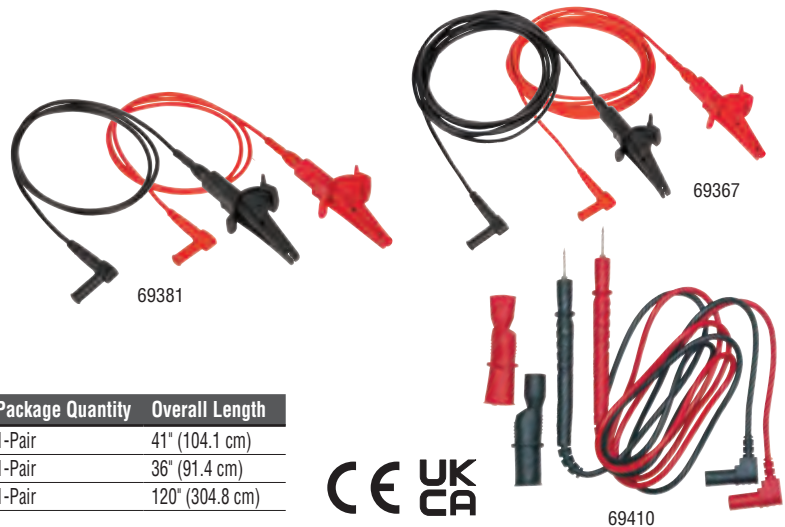

Cat. No.	UPC 0-92644+	Description	Package Quantity	Overall Length
69410	69410-3	Replacement Test Lead Set, Right Angle	1-Pair	41" (104.1 cm)
69381	69381-6	Heavy-Duty Alligator Clip Test Leads, 3 Feet	1-Pair	36" (91.4 cm)
69367	69367-0	Heavy-Duty Alligator Clip Test Leads, 10 Feet	1-Pair	120" (304.8 cm)



TOOL STORAGE

Core Tool Storage Features

- 1680d ballistic weave for durability
- Multiple pockets sized specifically to fit all your tools for complete organization
- Bright colored interior for easy tool visibility
- Tough, durable molded bottoms to protect from the elements



TRADESMAN PRO™ Tool Station Backpacks

Includes core tool storage features plus:

- Backpack with 21 pockets and large interior for maximum tool storage (Cat. Nos. 55482, 55655)
- Tool Station Backpack includes removable Flashlight with Worklight; A bright magnetic flashlight and broadcasting work light in one tool (Cat. No. 55655)
- Aircraft cable heavily reinforces the handle (Cat. No. 55485)



Cat. No.	UPC 0-92644+	Description	Special Features	Number of Pockets	Overall Length	Overall Width	Overall Height
55421BP-14	55467-4	Tool Bag Backpack	Hard front pocket	39	14.5" (36.8 cm)	7.25" (18.4 cm)	20" (50.8 cm)
55421BP14CAMO	55438-4	Tool Bag Backpack	REALTREE® Edge Camouflage Design	39	14.5" (36.8 cm)	7.25" (18.4 cm)	20" (50.8 cm)
55475	55475-9	Tool Gear Backpack	Tall interior pockets for long screwdrivers	35	7.375" (18.7 cm)	14.5" (36.8 cm)	17.5" (44.5 cm)
55482	55482-7	Tool Station Backpack	Large interior for maximum tool storage	21	14.5" (36.8 cm)	9" (22.9 cm)	19.25" (48.9 cm)
55485	55485-8	Tool Master Backpack	Removable tool caddy with handles	48	11" (27.9 cm)	13.5" (34.3 cm)	19.5" (50 cm)
55655	62025-6	Tool Station Backpack with Worklight	Includes removable flashlight with worklight	21	14.5" (36.8 cm)	9" (22.9 cm)	19.25" (48.9 cm)

Realtree Camouflage Design © 2022 of Jordan Outdoor Enterprises, Ltd., all rights reserved.

TRADESMAN PRO™ Rolling Tool Backpack

Includes core tool storage features plus:

- Rolling Tool Backpack features 3-Inch heavy-duty wheels that can truck through unpaved paths
- Easily convert from carrying the backpack to a rolling the tool bag by extending the telescoping handle and stowing the shoulder straps behind the back padding
- Handle wraps along the sides of the bag to provide extra support and stability when maneuvering around corners
- Extra padding on back extends over the hard bottom for carrying comfort
- Constructed with durable water resistant 1680d Ballistic Weave material
- Features a headlamp bracket that holds a Klein Tools Headlamp to illuminate either the interior of the tool bag or the external surroundings (Headlamp sold separately, Cat. Nos. 56062, 56049)
- Hard, molded front pocket helps protect items like phones and safety glasses
- 28 pockets for maximum tool and gear storage and includes a spacious interior for large hand tools
- Fully molded bottom protects from the elements
- Extra padding on the back extends over the hard bottom for carrying comfort
- Main zipper designed with lockable zipper pulls (lock not included)



Cat. No.	UPC 0-92644+	Description	Number of Pockets	Overall Length	Overall Width	Overall Height
55604	55604-3	Rolling Tool Backpack	28	17.5" (44.5 cm)	10.25" (26 cm)	25.5" (64.7 cm)

Headlamp and tools not included

TRADESMAN PRO™ Rolling Tool Bags

Includes core tool storage features plus:

- Rugged wheels provide high clearance to easily roll over rough terrain
- Hard top allows for stacking materials on top (Cat. No. 55473RTB)
- Load tested up to 250 lb (113 kg) (Cat. No. 55473RTB) and up to 200 lb (90.7 kg) (Cat. No. 55452RTB)
- Twist-lock Klein LED Light (Cat. No. 55437) or Wireless Speaker (Cat. No. AEPJS1) on front mount (items sold separately)



55473RTB



55452RTB



Cat. No.	UPC 0-92644+	Description	Special Features	Number of Pockets	Overall Length	Overall Width	Overall Height
55473RTB	55473-5	Tool Master Rolling Tool Bag	Metal latches keep lid closed	19	21.8" (55.4 cm)	15.4" (39.1 cm)	22.5" (57.2 cm)
55452RTB	55452-0	Rolling Tool Bag	Reinforced metal frame	24	19" (48.3 cm)	12.5" (31.8 cm)	14" (35.6 cm)

TRADESMAN PRO™ Lighted Tool Bag

Includes core tool storage features plus:

- Included removable LED light twists on/twists off so light can be positioned to illuminate inside the bag or the outside workspace

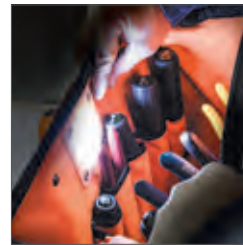
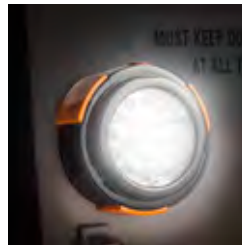

Tools not included



55431

Cat. No.	UPC 0-92644+	Number of Pockets	Overall Length	Overall Width	Overall Height
55431	55431-5	31	15.25" (38.7 cm)	8" (20.3 cm)	14" (35.6 cm)

TRADESMAN PRO™ Totes

Includes core tool storage features plus:

- Double stitched seams for extra durability
- Resized pockets to better fit tools
- Large zipper pockets for tools and small parts
- Shoulder strap with extra padding
- Longer pockets for screwdrivers



554158-14



5541610-14

Cat. No.	UPC 0-92644+	Number of Pockets	Overall Length	Overall Width	Overall Height
554158-14	55462-9	20	8.75" (22.2 cm)	8.75" (22.2 cm)	17" (43.2 cm)
5541610-14	55463-6	40	10" (25.4 cm)	10.25" (26 cm)	12.25" (31.1 cm)

TOOL STORAGE

TRADESMAN PRO™

14-Pocket Shoulder Pouch

Includes core tool storage features plus:

- Double stitched seams for extra durability
- Resized pockets to better fit tools
- Shoulder strap with extra padding
- Longer pockets for screwdrivers



55419SP-14

Cat. No.	UPC 0-92644+	Number of Pockets	Material	Overall Length	Overall Width	Overall Height
55419SP-14	55466-7	14	1680d Ballistic Weave	11" (27.9 cm)	10.5" (26.7 cm)	10" (25.4 cm)

TRADESMAN PRO™

Hard Cases

- Hard shell protects tools, meters, small parts and tech devices
- Soft interior lining
- Durable zipper closure



5189

5184

Cat. No.	UPC 0-92644+	Number of Pockets	Overall Length	Overall Width	Overall Height
5184	55434-6	1	8.75" (22.2 cm)	6.5" (16.5 cm)	2.25" (5.7 cm)
5189	55435-3	1	10.25" (26 cm)	5.5" (14 cm)	2.25" (5.7 cm)

Zipper Bags

- Includes four assorted colors to organize and categorize important tools (Cat. No. 5140)



55559



55470



5140

Cat. No.	UPC 0-92644+	Material	Color	Overall Width	Overall Height	Overall Length
Stand-Up Zipper Bags						
55559	55559-6	1680d Ballistic Polyester, 2520d Ballistic Polyester Bottom	Gray/Black, Blue/Black	2" (5.1 cm)	4.5" (11.4 cm)	14" (35.6 cm); 7" (17.8 cm)
55470	55470-4	1680d Ballistic Nylon, 2520d Ballistic Nylon Bottom	Orange/Black; Gray/Black	1.125" (2.9 cm)	6.5" (16.5 cm); 7.5" (19.1 cm)	8.5" (21.6 cm); 9" (22.9 cm)
Canvas Zipper Bags — 4 Pack						
5140	55367-7	No. 10 Canvas	Blue, Yellow, Olive, Orange	0.7" (1.8 cm)	7" (17.8 cm)	12.5" (31.8 cm)

TRADESMAN PRO™ Padded Suspenders

- Tear resistant
- Fully adjustable
- Durable nylon web straps for long wear
- Heavy duty padding for comfort
- Easy snap hook fastening system

Cat. No.	UPC 0-92644+	Color	Size	Strap Width
55400	55400-1	Black	One Size Fits Most	1.5" (3.8 cm)

⚠WARNING: This is NOT an occupational protective belt. NOT for fall arrest or back support.



55400



TRADESMAN PRO™ Modular Tool Pouch System

- Build your own tool belt and storage system
- Quick-release clip design on four styles of pouches allows for easy change from belt to wall rack
- 32° clip design on pouches to keep contents upright when changing from belt to wall rack
- Pouches constructed of 1680d ballistic weave for durability
- Wall Rack securely stores three Modular Tool Pouches, and comes with mounting hardware to secure in garage, shop, or work van
- Tool Belts with thick, rugged belt ends have side handles for ease of lifting, metal connection points to attach suspenders (Cat. No. 50400) for extra support, and loop tape measure holder
- 2" (5.1 cm) wide belt features padded liner with breathable mesh interior
- Thick, rugged leather belt ends
- Side handles for ease of lifting
- Includes metal connection points to attach suspenders for extra support
- Patent Pending



55917



55914



55920



55912



55913



55921

Modular Pouches						
Cat. No.	UPC# 0-92644+	Description	Number of Pockets	Material	Belt Connection	Belt Width
55912	55912-9	Piping Tool Pouch with Belt Clip	7	1680d Ballistic Weave	Click Lock™	Up to 2" (5.1 cm)
55913	55913-6	Parts Pouch with Belt Clip	7			
55914	55914-3	Trimming Pouch with Belt Clip	8			
55917	55917-4	Drill Pouch with Belt Clip	4			
Modular Wall Rack						
Cat. No.	UPC 0-92644+	Description	Material	Overall Length	Overall Width	Overall Height
55921	55921-1	Wall Rack	Heavy-Duty Anodized Aluminum	24" (61 cm)	2" (5.1 cm)	1.5" (3.8 cm)
Modular Tool Belts						
Cat. No.	UPC 0-92644+	Description	Material	Waist Size	Overall Width	
55918	55918-1	Tool Belt - M	Ballistic Polyester and Leather	31" to 34" (78.7 to 86.4 cm)	5" (12.7 cm)	
55919	55919-8	Tool Belt - L		35" to 39" (88.9 to 99.1 cm)		
55920	55920-4	Tool Belt - XL		40" to 44" (101.6 to 111.8 cm)		

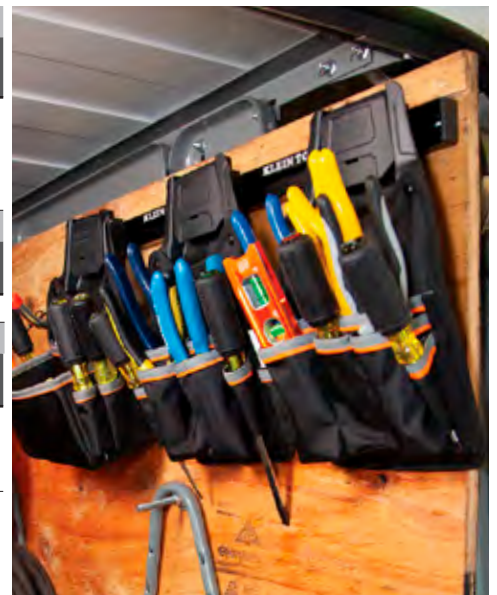

⚠WARNING: This is NOT an occupational protective belt. NOT for fall arrest or back support.

TOOL KITS

14-Piece Tool Kit



Cat. No.	UPC 0-92644+	Kit Contains	Weight
80014	80014-6		9.6 lb (4.4 kg)

Cat. No.	Description
D213-9NETP	9" High-Leverage Lineman's Pliers, Tape Puller
D248-8	8" High-Leverage Diagonal-Cutting Pliers, Angled Head
D203-8	8" Long-Nose Pliers, Side-Cutting
D502-10	10" Pump Pliers
11045	Wire Stripper/Cutter
603-3	#1 Phillips Cushion-Grip Screwdriver, 3" Round Shank
603-4B	#2 Phillips Wire Bending Cushion-Grip Screwdriver, 4" Round Shank
605-4	1/4" Cabinet Cushion-Grip Screwdriver, 4" Round Shank
605-6	1/4" Cabinet Cushion-Grip Screwdriver, 6" Round Shank
670-6	3/16" Cabinet Rapi-Driv® Cushion-Grip Screwdriver, 6" Round Shank
9125	25' Tape Measure, Single Hook
60159	Standard Safety Glasses, Clear
5225	Adjustable PolyWeb Tool Belt
5164	8-Pocket Tool Pouch Slotted

⚠ WARNING: Do NOT open the tape measure case. Spring motor is under tension, and opening may cause injury.

⚠ WARNING: This is NOT an occupational protective belt.

28-Piece Tool Kit

New list of products, same catalog number



Cat. No.	UPC 0-92644+	Kit Contains	Weight
80028	80028-3		17.25 lb (7.8 kg)

Cat. No.	Description
D248-8	8" High-Leverage Diagonal-Cutting Pliers, Angled Head
D203-8	8" Long-Nose Pliers, Side-Cutting
D213-9NETP	9" High-Leverage Lineman's Pliers, Tape Puller
D502-10	10" Pump Pliers
11045	Wire Stripper/Cutter
1005	Crimping/Cutting Tool, For Connectors
601-6	3/16" Cabinet Cushion-Grip Screwdriver, 6" Round Shank
605-4	1/4" Cabinet Cushion-Grip Screwdriver, 4" Round Shank
602-6	5/16" Keystone Cushion-Grip Screwdriver, 6" Round Shank
603-4	#2 Phillips Cushion-Grip Screwdriver, 4" Round Shank
662	#2 Square-Recess Cushion-Grip Screwdriver, 4" Round Shank
85191	Conduit-Fitting and Reaming Cushion-Grip Screwdriver, 2.5" Round Shank
630-3/16	3/16" Cushion-Grip Nut Driver, 3" Hollow Shaft
630-1/4	1/4" Cushion-Grip Nut Driver, 3" Hollow Shaft
630-5/16	5/16" Cushion-Grip Nut Driver, 3" Hollow Shaft
630-11/32	11/32" Cushion-Grip Nut Driver, 3" Hollow Shaft
630-3/8	3/8" Cushion-Grip Nut Driver, 3" Hollow Shaft
630-7/16	7/16" Cushion-Grip Nut Driver, 3" Hollow Shaft
630-1/2	1/2" Cushion-Grip Nut Driver, 3" Hollow Shaft
70550	Pro Folding Hex Key Set
NCVT-3P	Dual-Range Non-Contact Voltage Tester, Flashlight
RT210	GFCI Receptacle Tester
44131	Folding Utility Knife
9125	25' Tape Measure, Single Hook
935R	9" Aluminum Torpedo Level
55421BP-14	39-Pocket Tradesman Pro™ Tool Bag Backpack
5139	Canvas Zipper Bag
60159	Standard Safety Glasses, Clear



12-Piece Tool Kit

New list of products, same catalog number

Cat. No.	UPC 0-92644+	Kit Contains	Weight
92003	92003-5		6.83 lb (3.1 kg)



Cat. No.	Description
D248-8	8' High-Leverage Diagonal-Cutting Pliers, Angled Head
D203-8	8' Long-Nose Pliers, Side-Cutting
D213-9NE	9' High-Leverage Lineman's Pliers
11045	Wire Stripper/Cutter
601-6	3/16" Cabinet Cushion-Grip Screwdriver, 6" Round Shank
605-4	1/4" Cabinet Cushion-Grip Screwdriver, 4" Round Shank
603-4	#2 Phillips Cushion-Grip Screwdriver, 4" Round Shank
662	#2 Square-Recess Cushion-Grip Screwdriver, 4" Round Shank
9375	7.5m Tape Measure, Magnetic Double Hook, Metric and Imperial
935R	9" Aluminum Torpedo Level
5719	PowerLine™ Cordura® 18-Pocket Electrician's Tool Pouch
5705	PowerLine™ Web Work Belt

Cordura® is a registered trademark of INVISTA for durable fabrics

⚠WARNING: This is NOT an occupational protective belt.

⚠WARNING: Do NOT open the tape measure case. Spring motor is under tension, and opening may cause injury.



CONTRACTOR KIT BUILDING PROGRAM

Klein Tools offers pre-approved contractors custom kits that can be used to satisfy tool inventory needs related to service vans and jobsite boxes. These kits provide convenience and savings which is passed on through authorized Klein distributors to the contractor.

**For more information, contact your Klein Tools representative
or our HVAC team at HVAC@kleintools.com.**

- Klein Tools can build a custom tool set to match any vocational school's or contractor's required tool list
- School/contractor specifies the contents of the kit
- Kit is assigned a unique Klein SKU number
- Purchase through the Klein distributor of your choice
- Minimum Quantity is (10) kits per order

**Ask your Klein Tools representative
for more information!**





For over 165 years
Klein Tools® has been
the brand tradespeople have
trusted to **cool America!**

That trust is invaluable to us, and every day we strive to keep building on that trust. We work hard each day to produce tools to help you perform your job better and more efficiently. We look to you for feedback, good or bad, to continuously improve our product offerings. And we make every effort to develop, design and manufacture these tools right here in the USA. Our commitment is always to you, the customer, and to continue as a US manufacturer of quality tools.

**KLEIN
TOOLS®** 

HVAC|R



See our complete line of **HVAC** products
www.kleintools.com/HVAC



For Professionals
SINCE 1857™

© 2022 Klein Tools, Inc.
Lincolnshire, IL 60069
96520 Rev. 09/22 C